

# 30 DK-162 CARGO FRONT

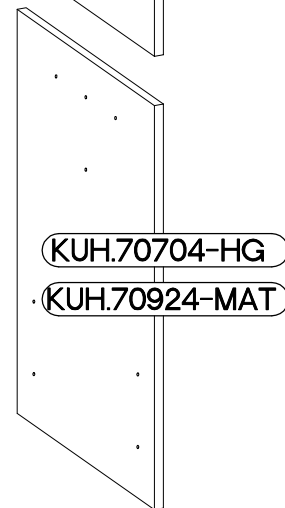

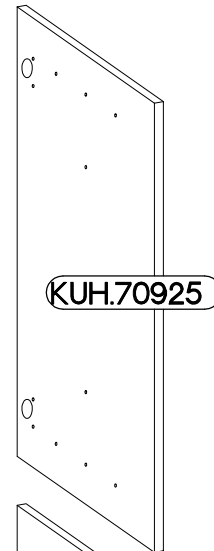
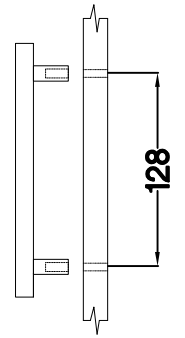
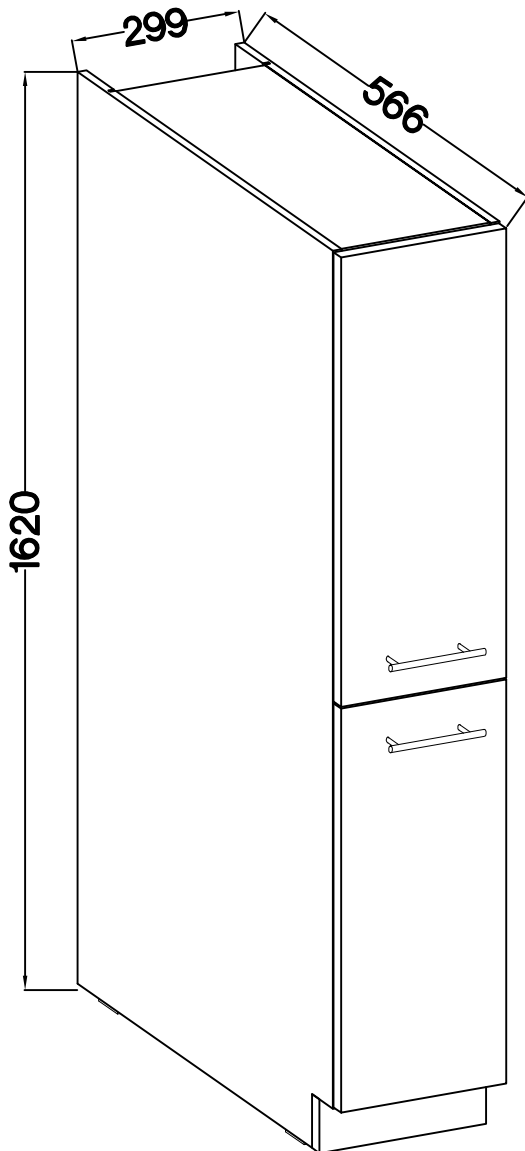
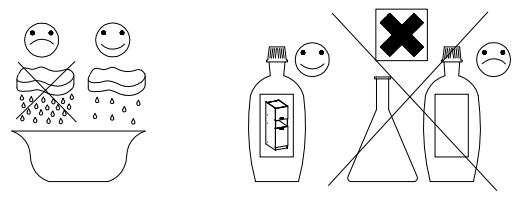

M4x22mm	L=128mm
U	S
4	2

LEFT

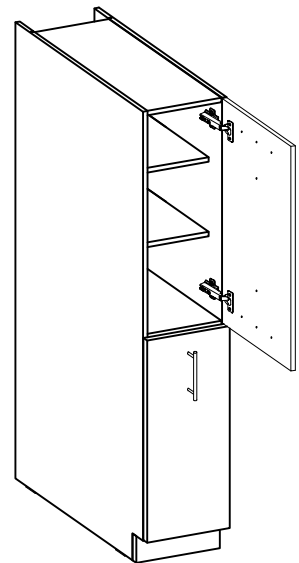
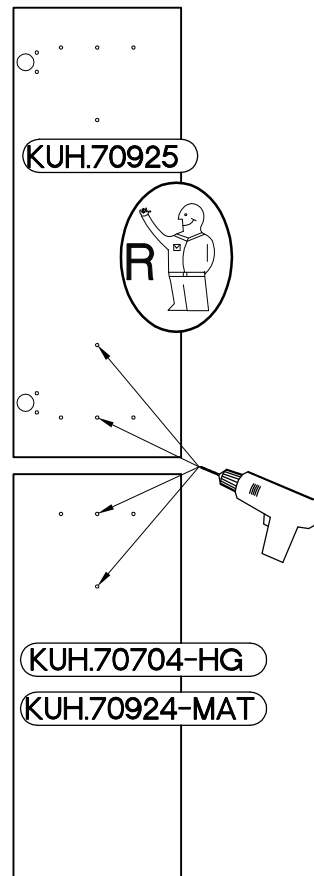
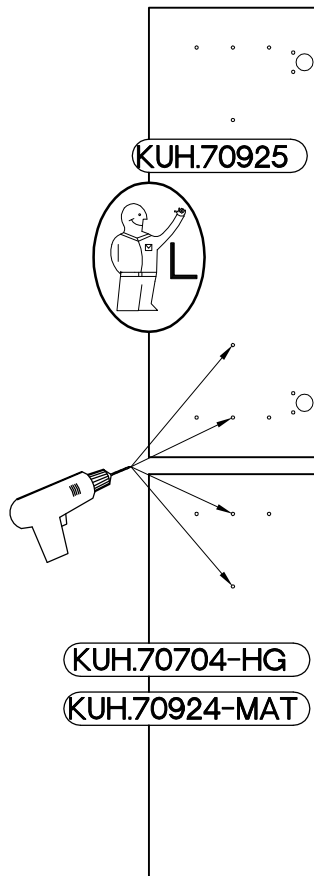
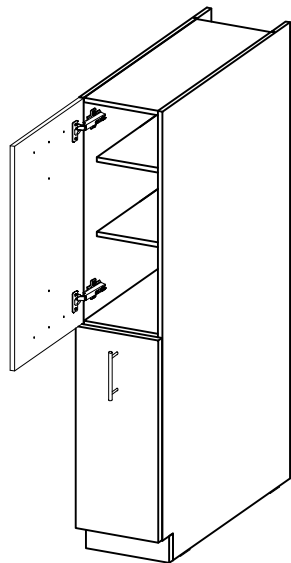
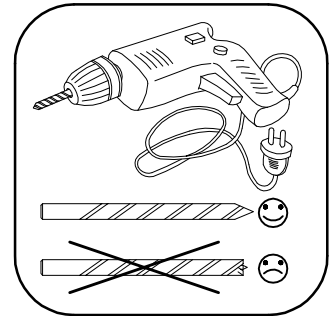
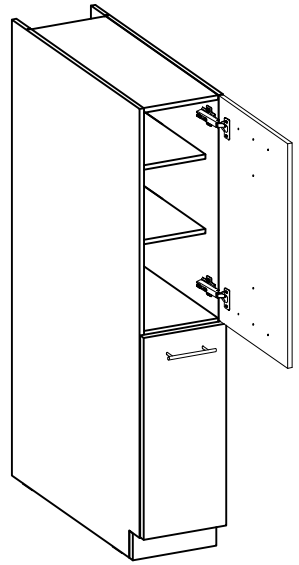
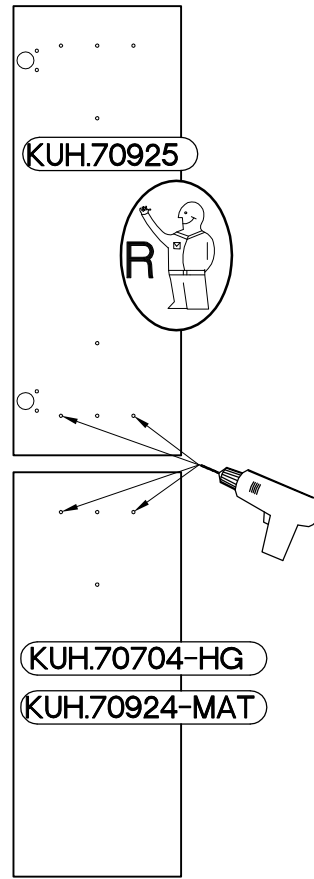
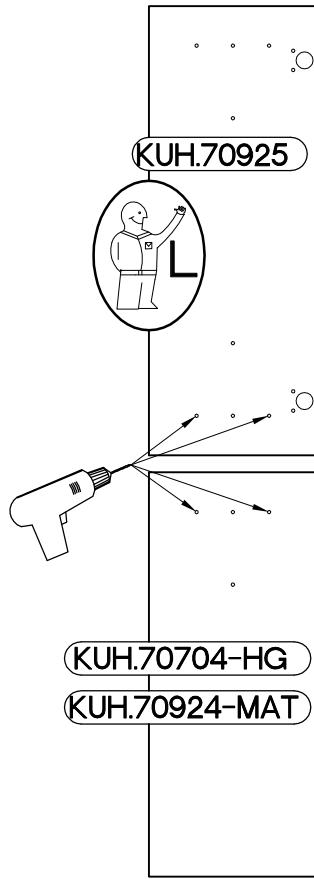
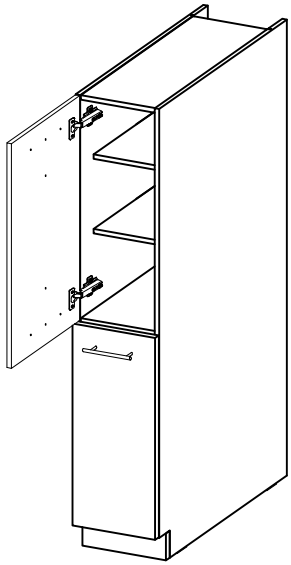
RIGHT



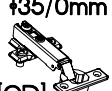

2

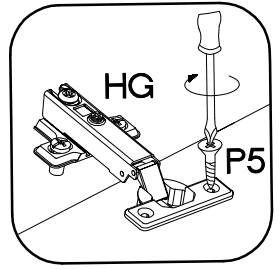
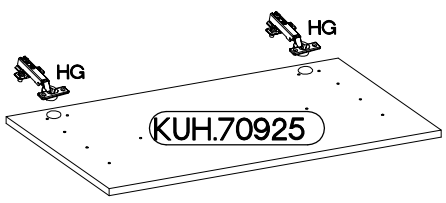
$\varnothing 35/0\text{mm}$  [CD] HG 2	$\varnothing 3.5 \times 13\text{mm}$  P5 4
---	---



3

$M4 \times 22\text{mm}$  U 2	$L=128\text{mm}$  S 1
--	---

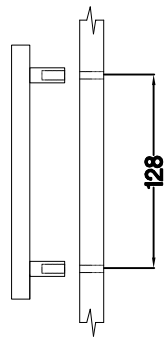
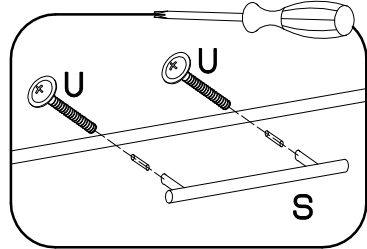
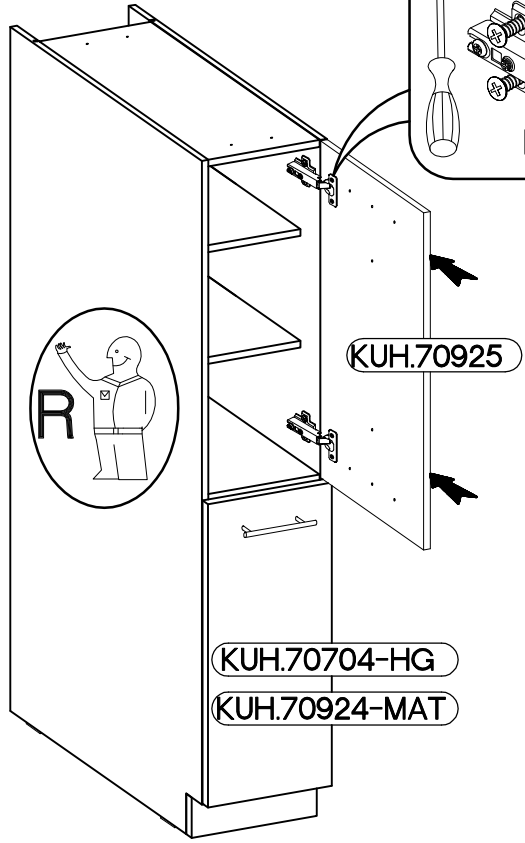
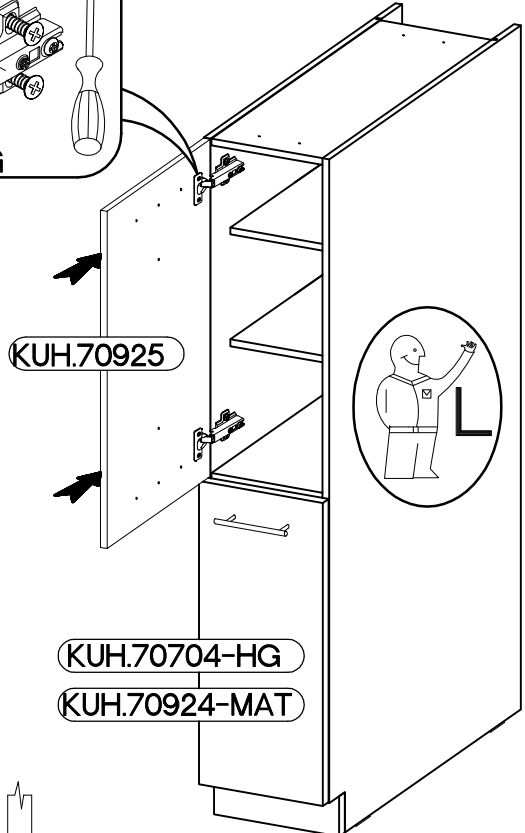
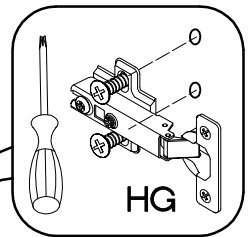
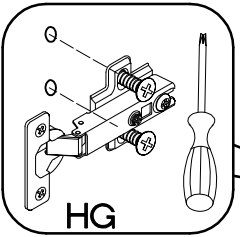

### VARIANT HIGH GLOSS

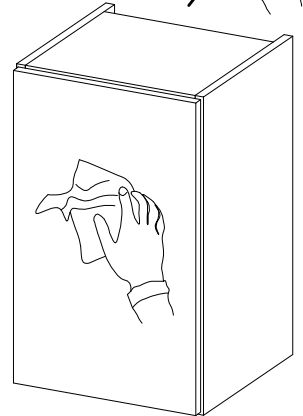
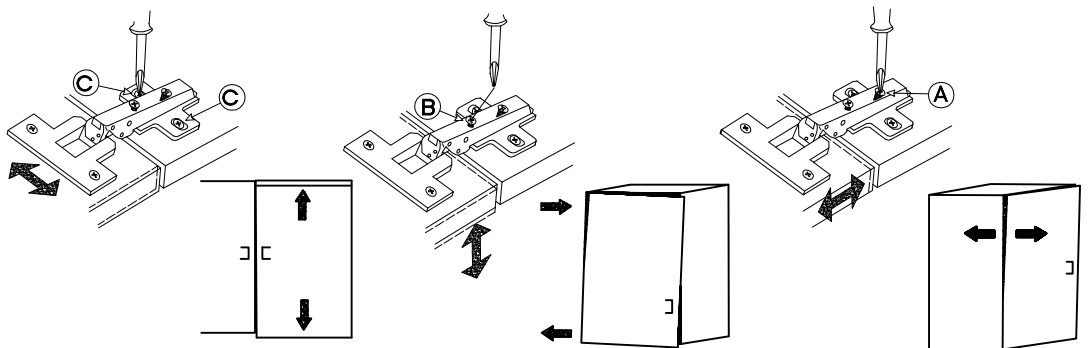
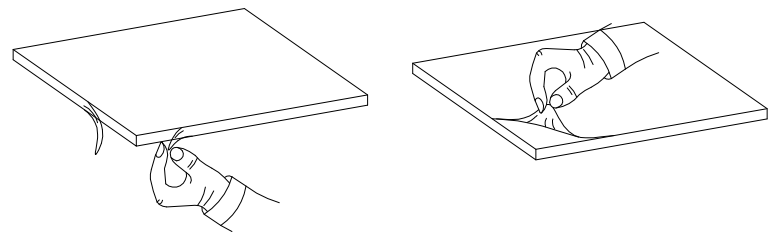

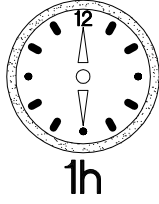
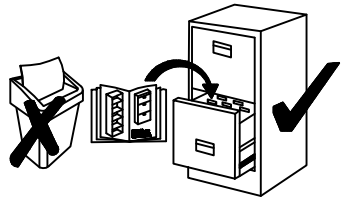
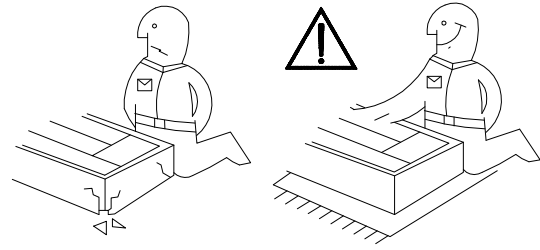
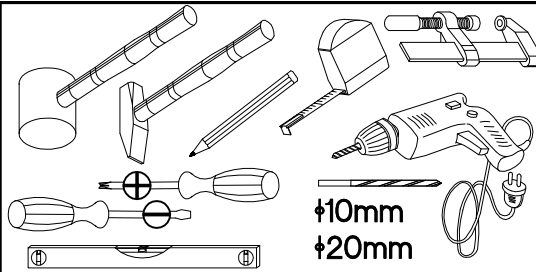
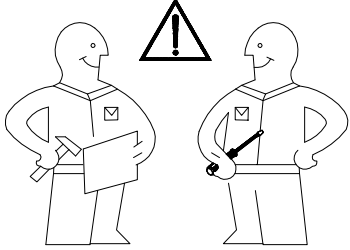

**30 DK-162  
CARGO**

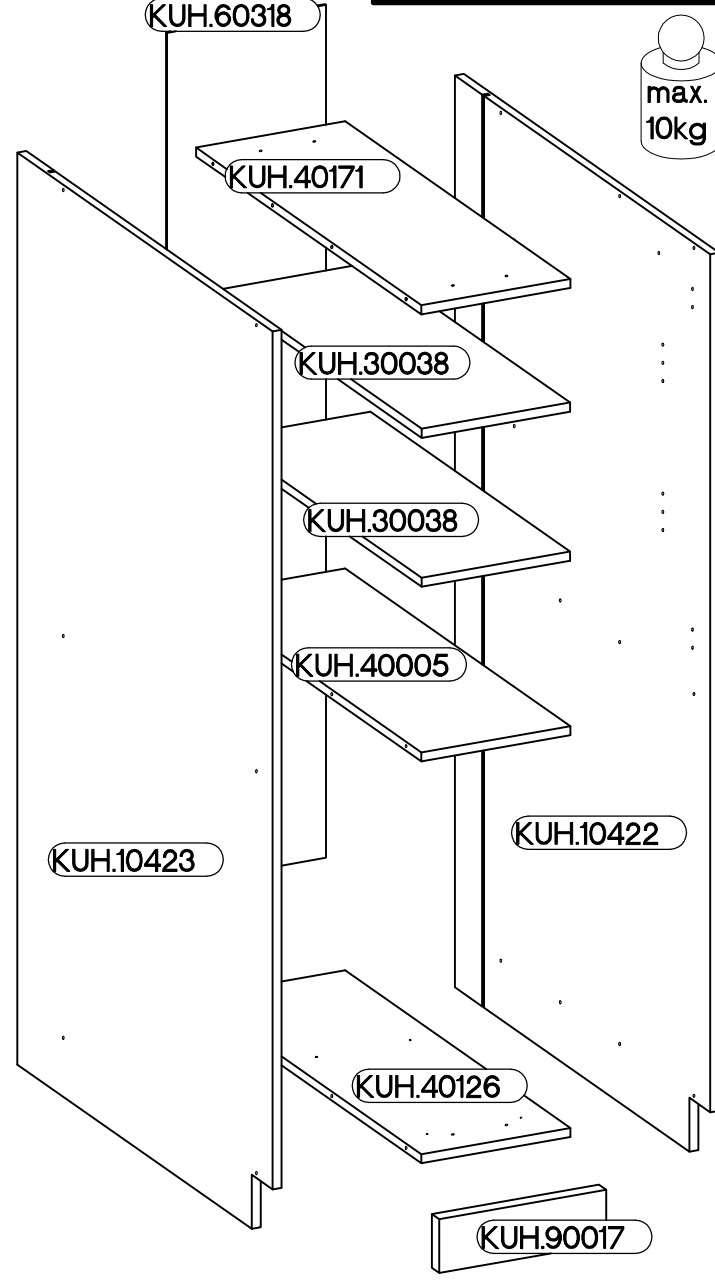
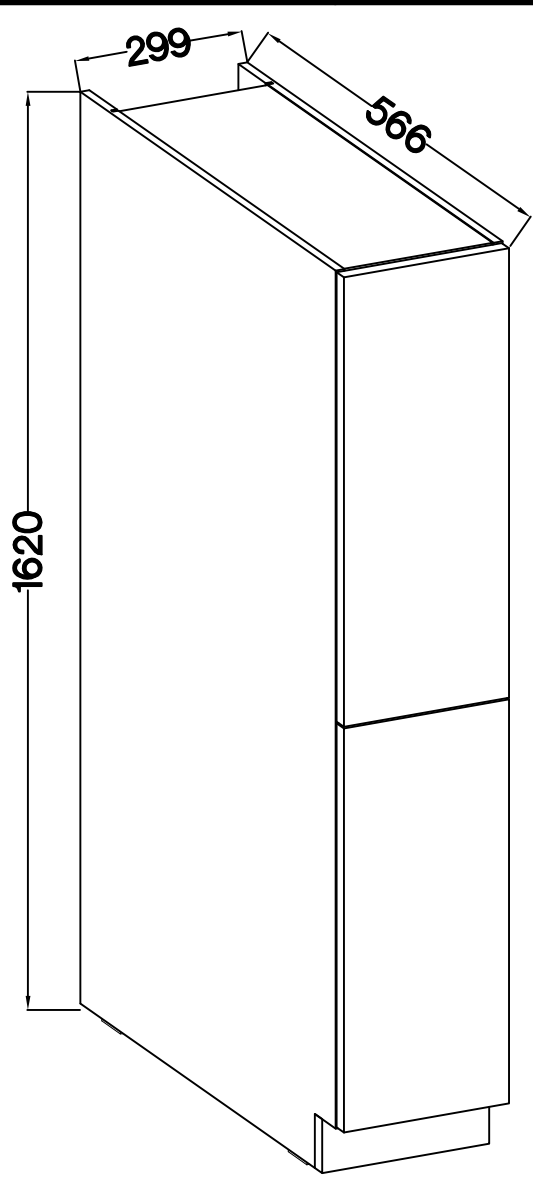
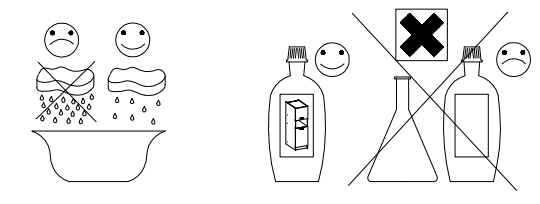

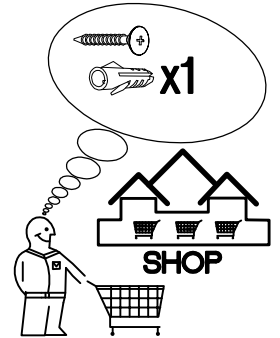

max. 10kg  
KUH.30038  
KUH.40005

 A 12	 B 12	 E1 12	 E9 2	 F2 4	 HG 2
 J 8	 L25 1	 O 1	 P4 2	 P5 6	 P7 8-10



**ISM-KUH-01611**

# 1

6.5x48x16	+8x30mm
	
F2	A
4	12

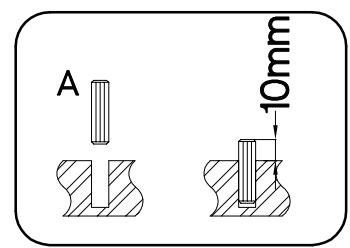
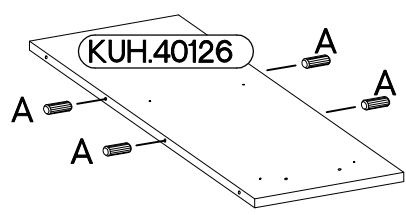
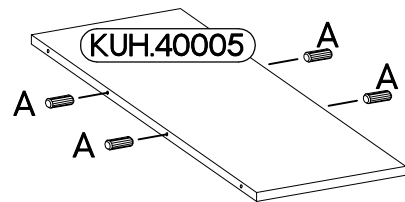
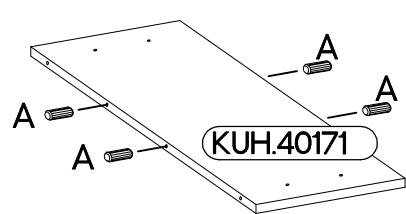
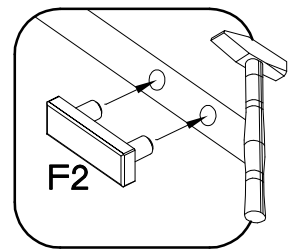
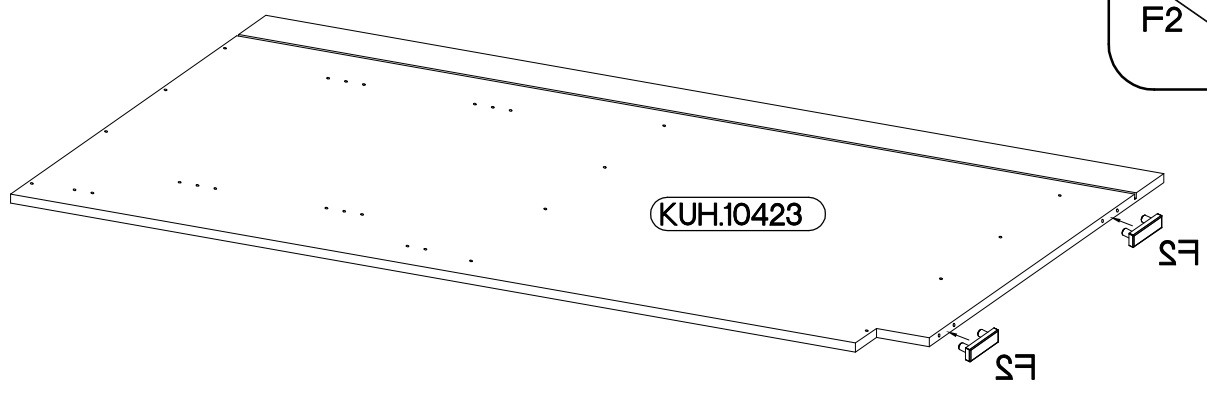
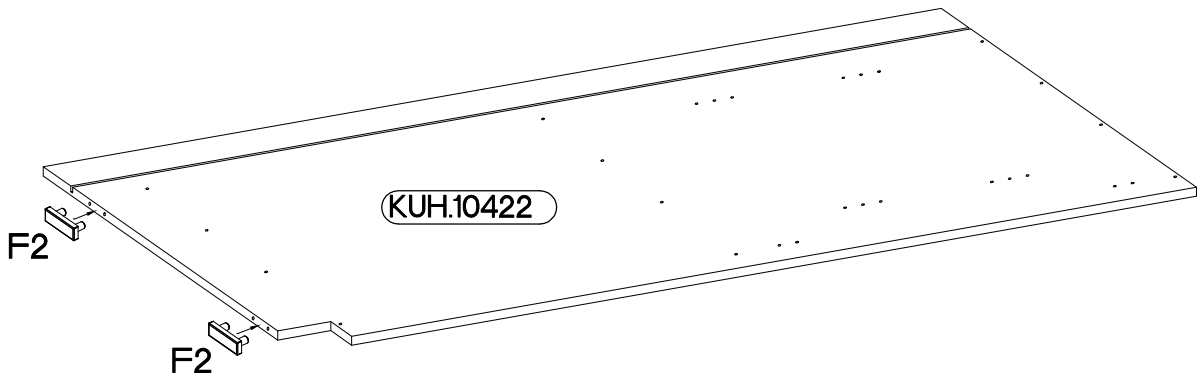
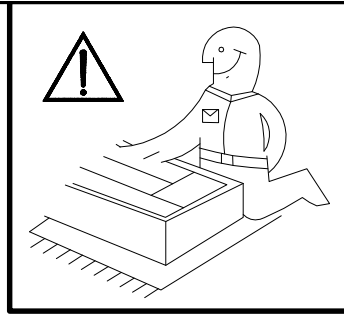

# 2

6,4 x 50mm

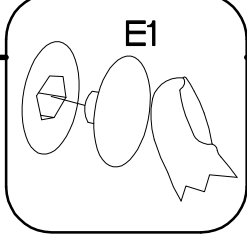
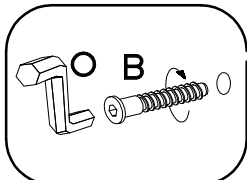
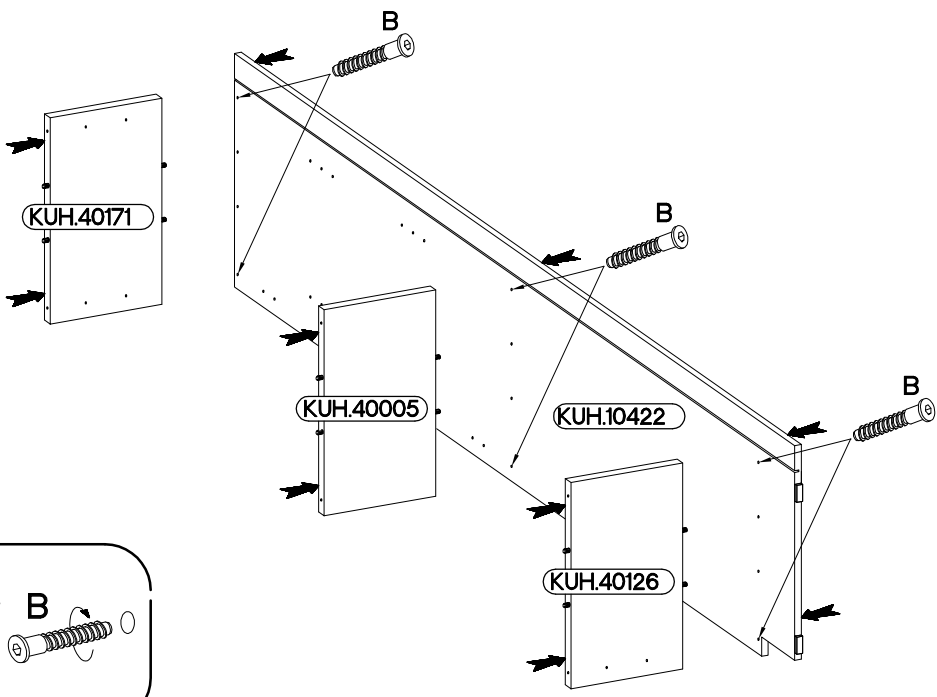
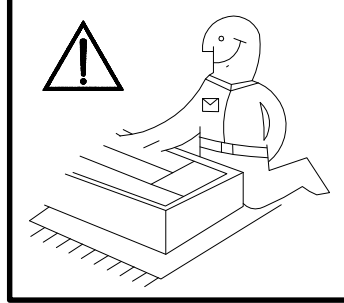
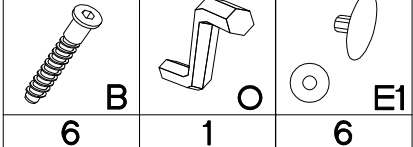

# 3

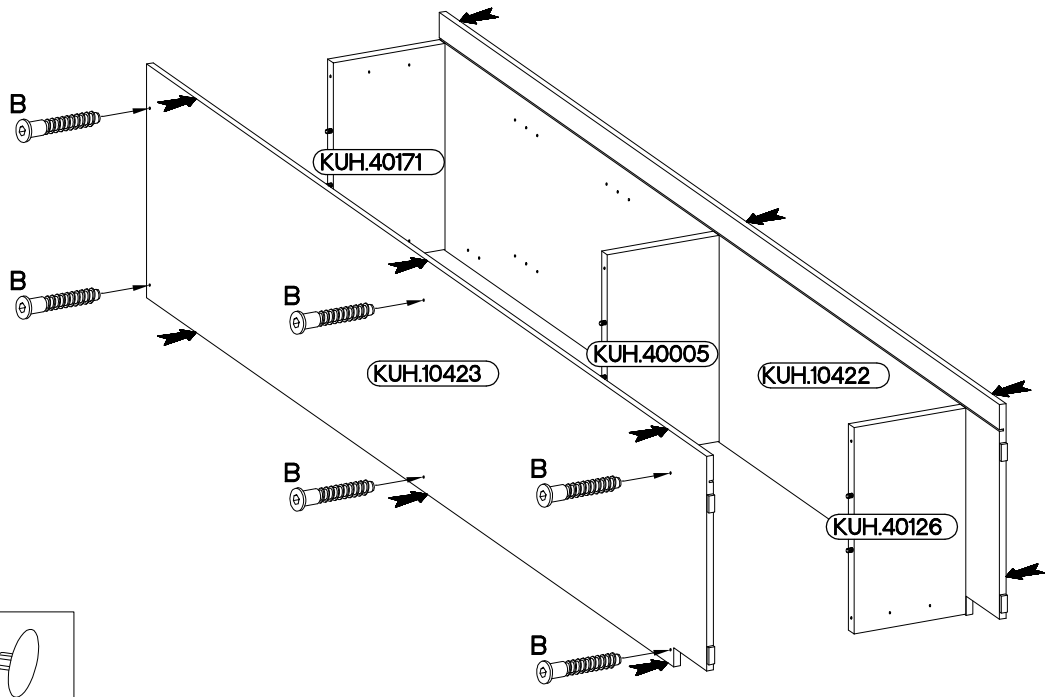

6,4 x 50mm

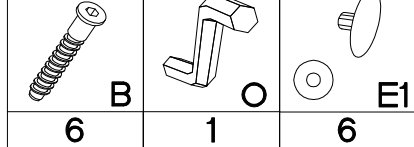

4

±3.0x20mm



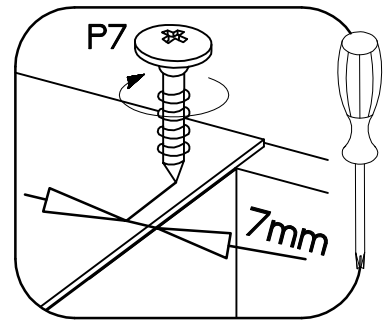
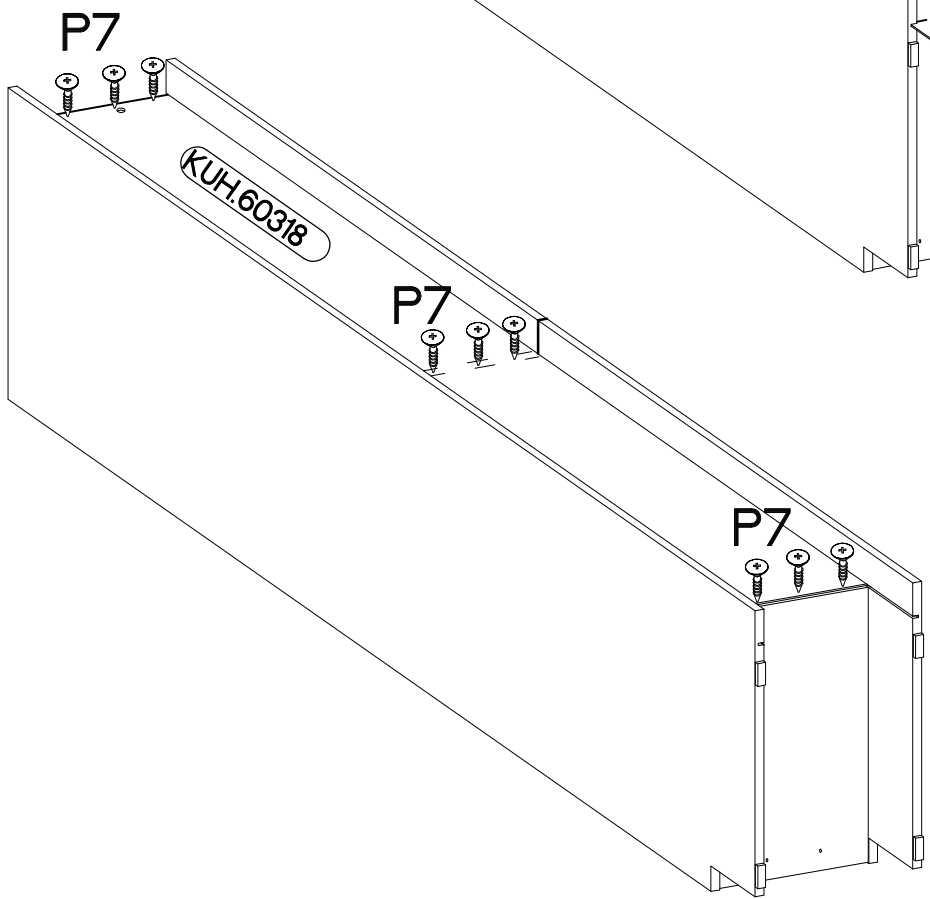
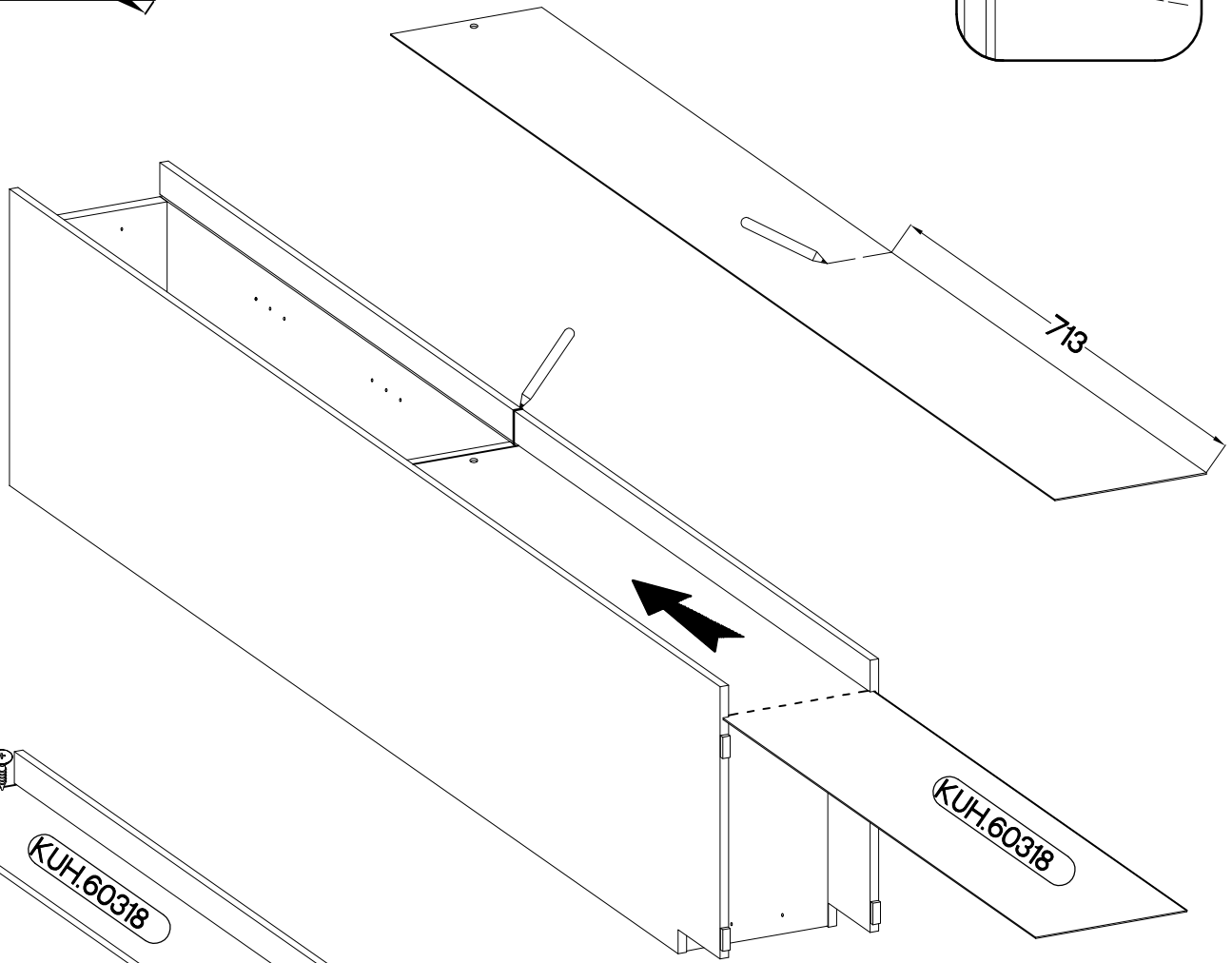
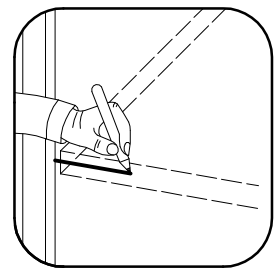
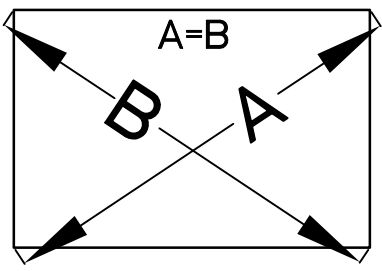
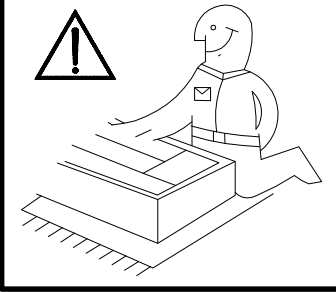
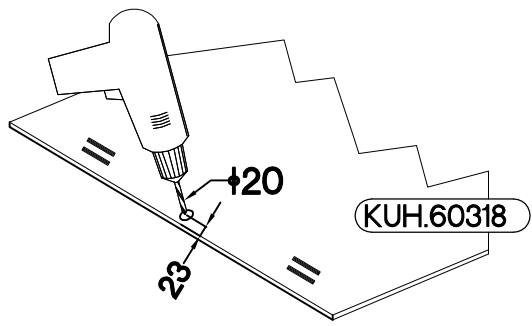

P7

8-10



5

 P4 2	 E9 2
---	---

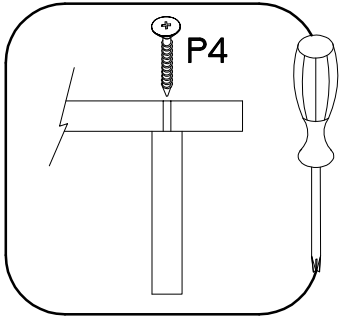
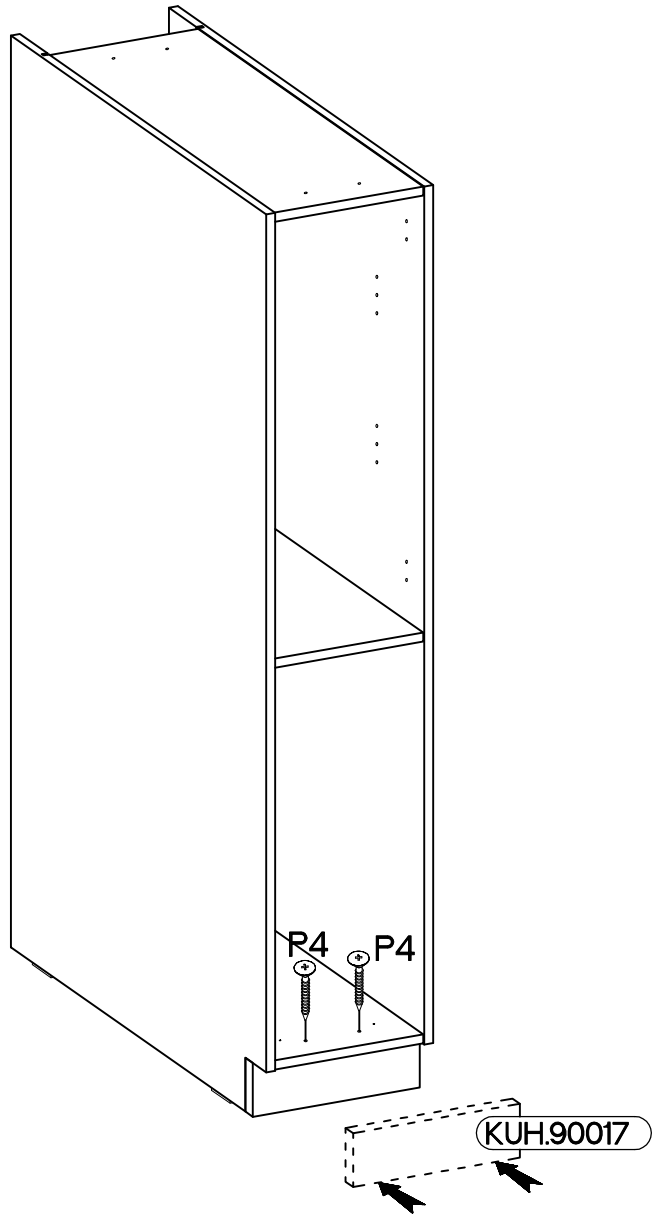

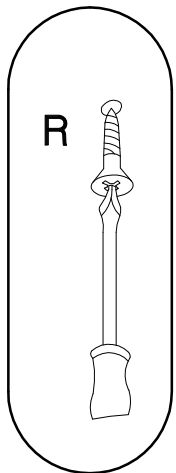
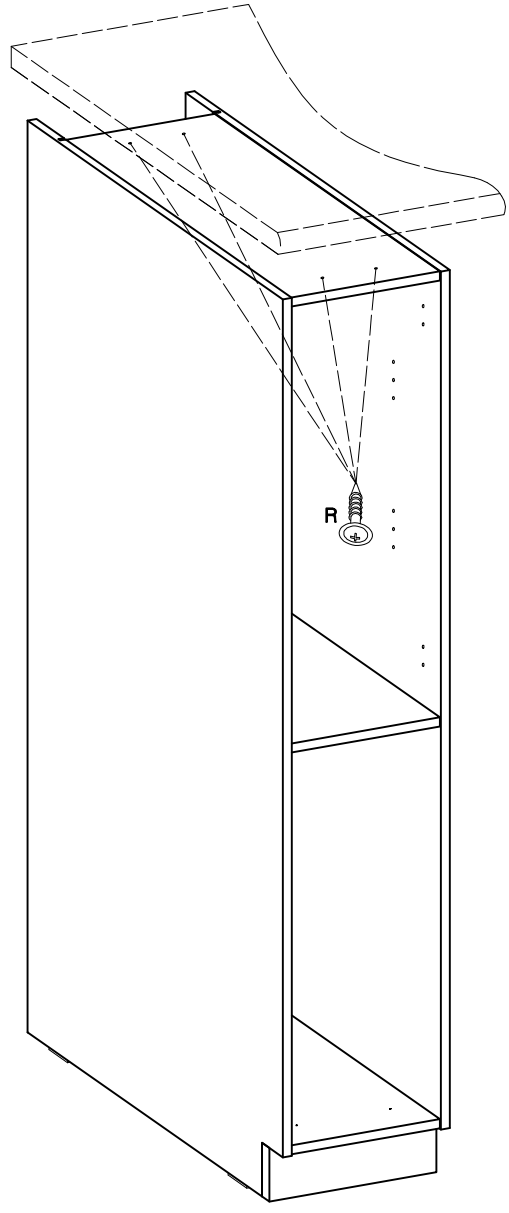

6

 R 4
---



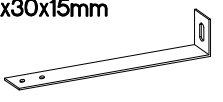

120x30x15mm	13.5x13mm
	
L25	P5
1	2

1.

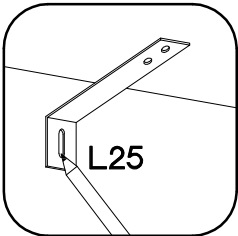

2.

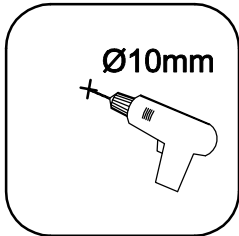

3.

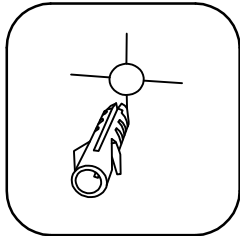

4.

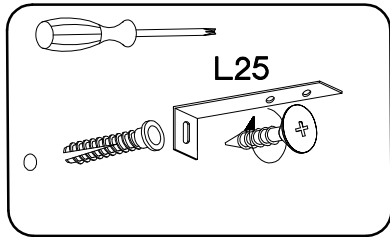

5.

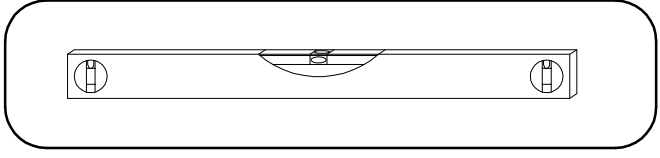
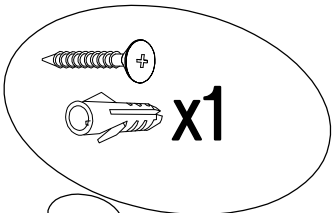
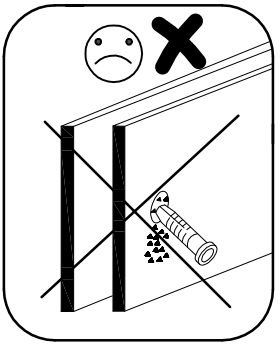
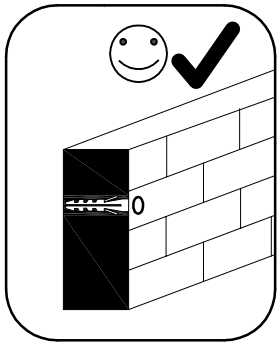
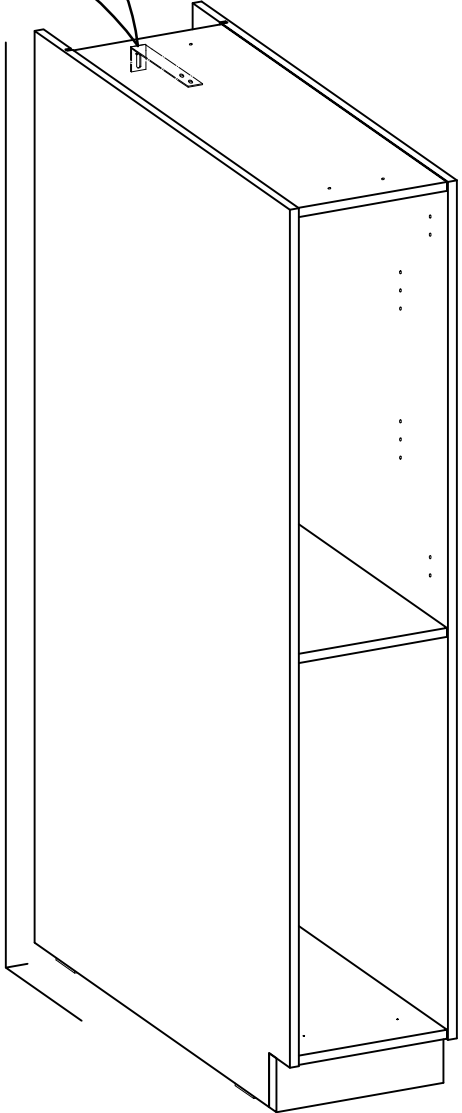
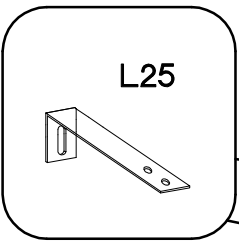
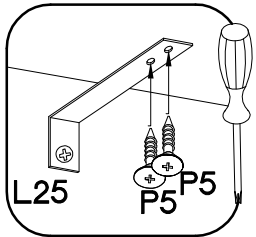

8

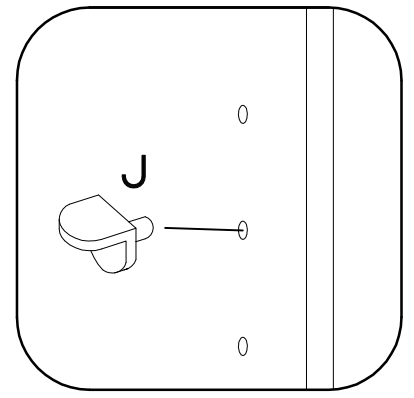
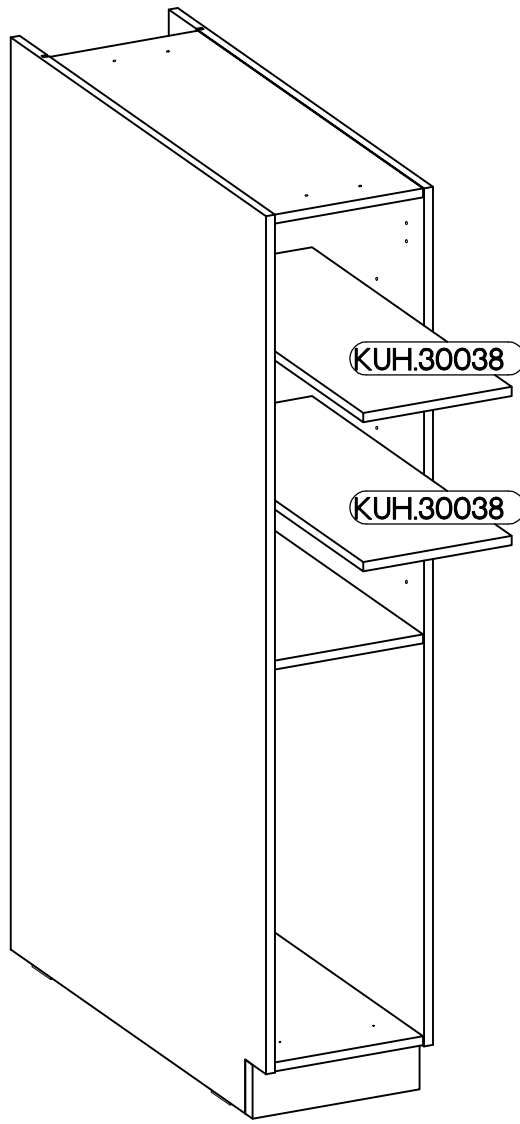
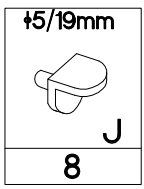

9

FRONT

