

60 DPM-2100 2F FRONT

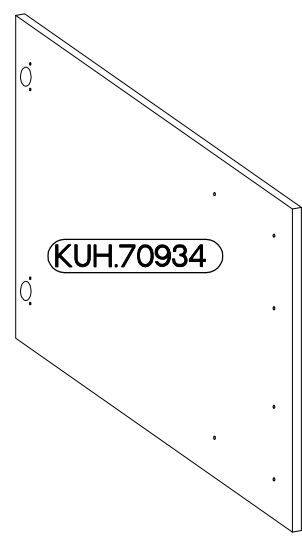

M4x22mm	L=128mm
U	S
4	2

ISM-KUH-01643

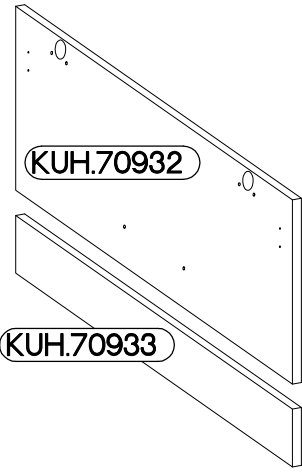
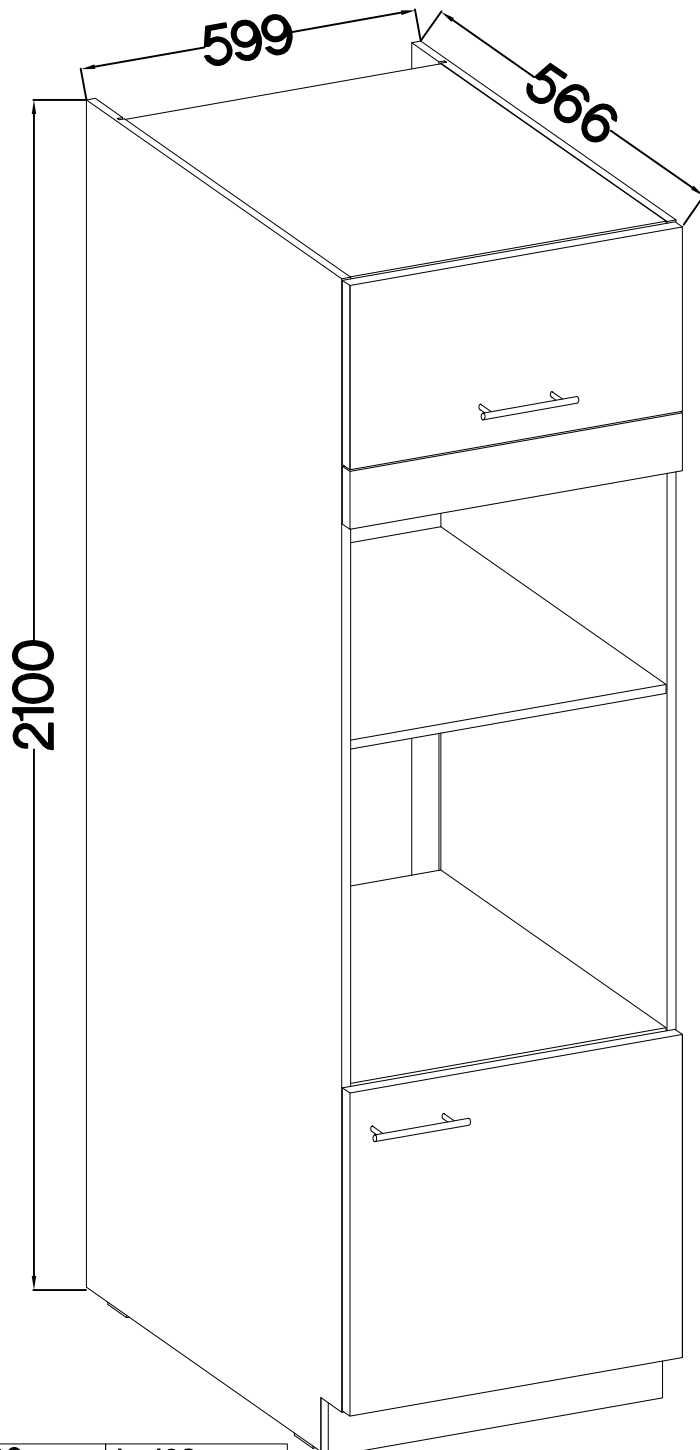
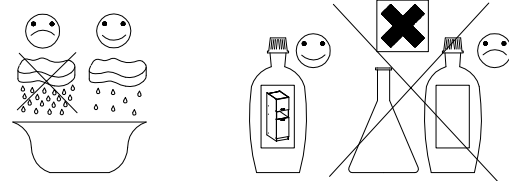

LEFT



RIGHT

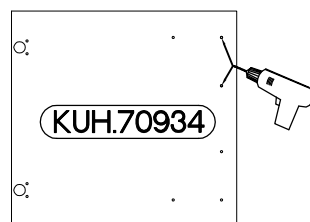
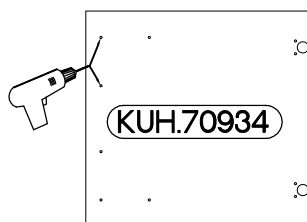
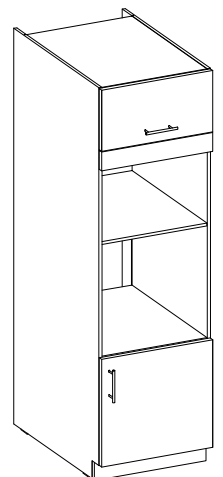
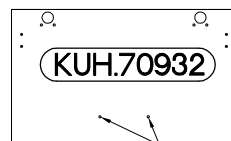
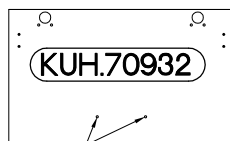
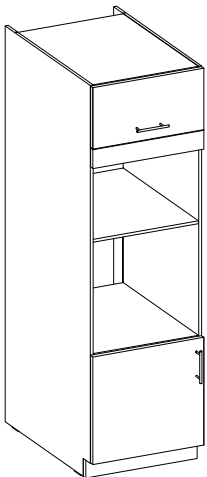
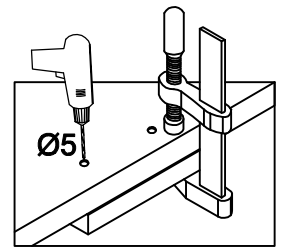
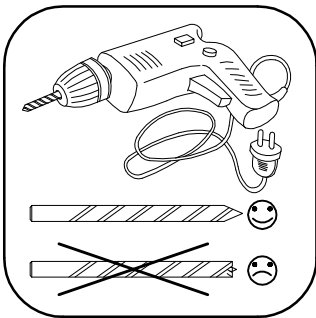
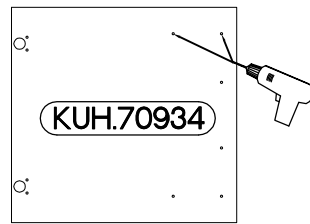
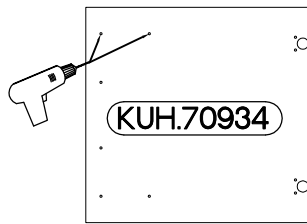
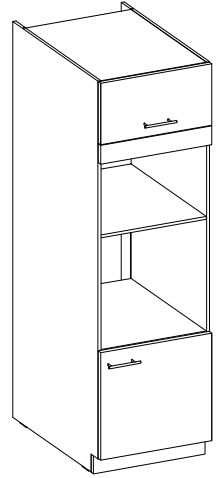
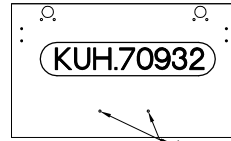
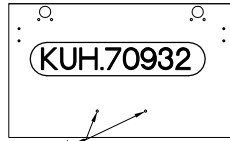
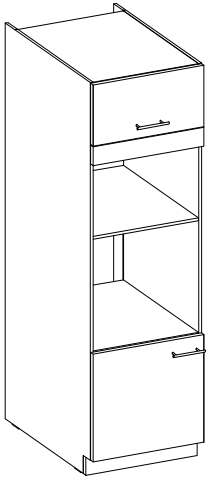

2

±35/0mm [CD] HG 4	±3.5x13mm P5 8
----------------------------	----------------------

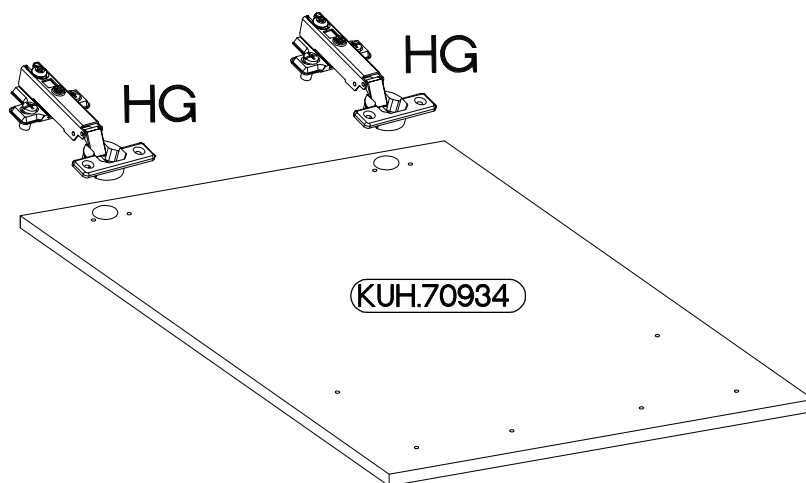
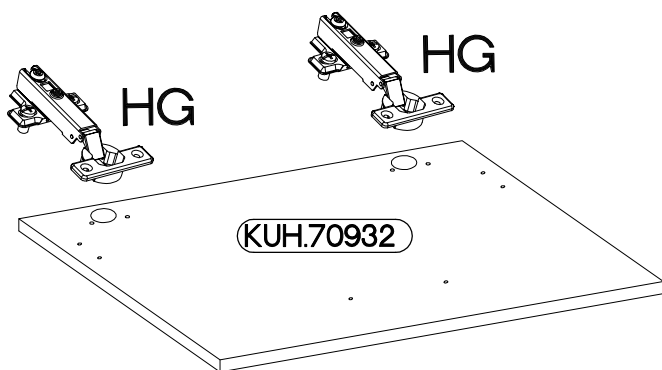
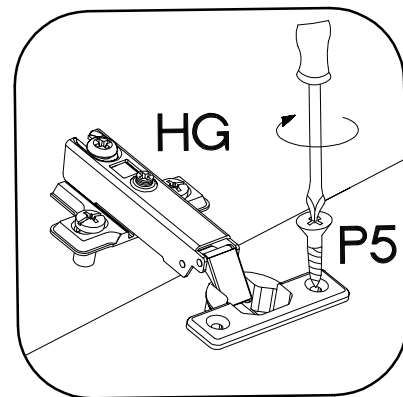

3

T3 2	±4.0x16mm P1 2
---------	----------------------

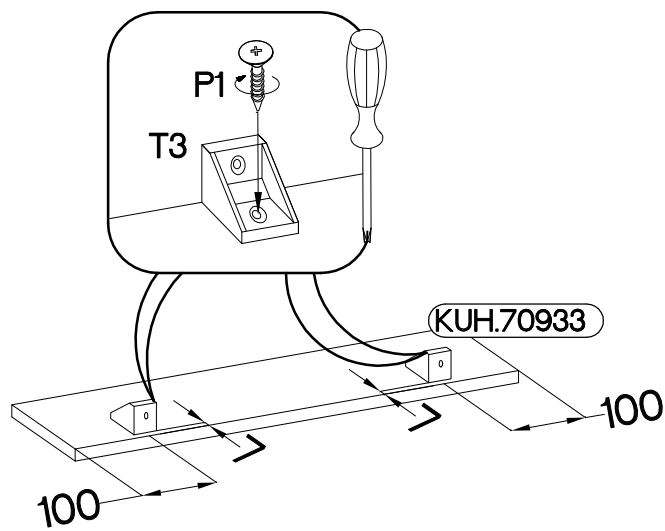

4

4.0x16mm

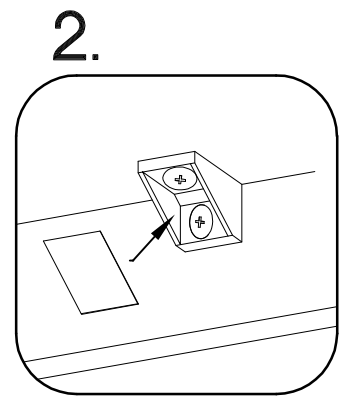
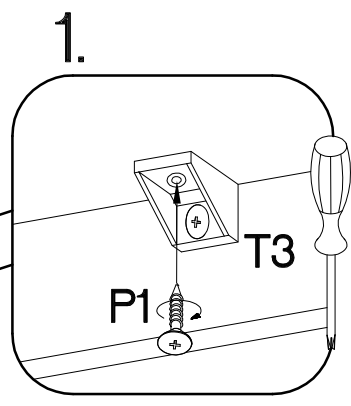
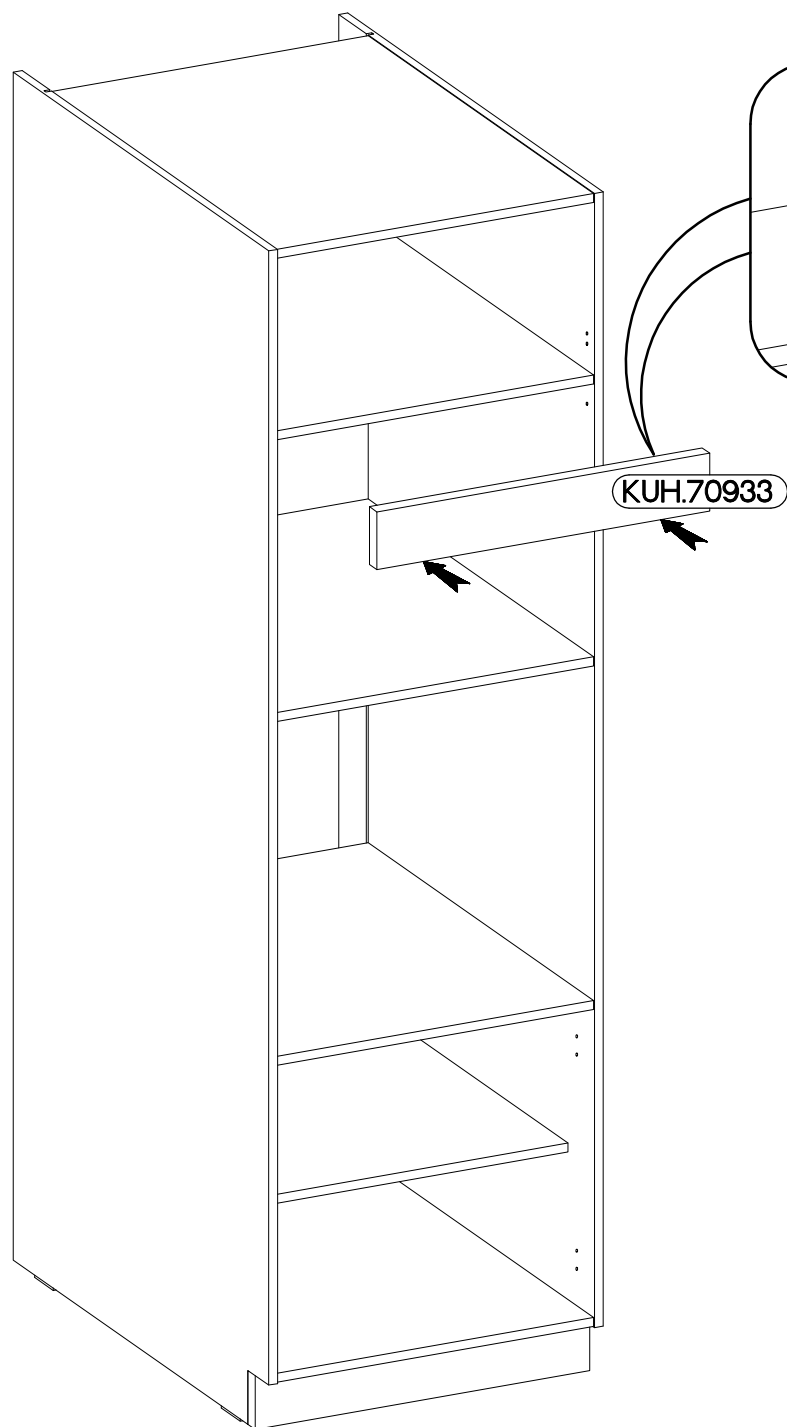
P1
2

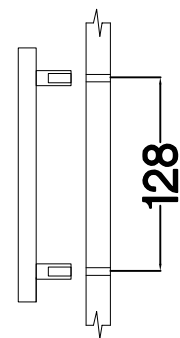
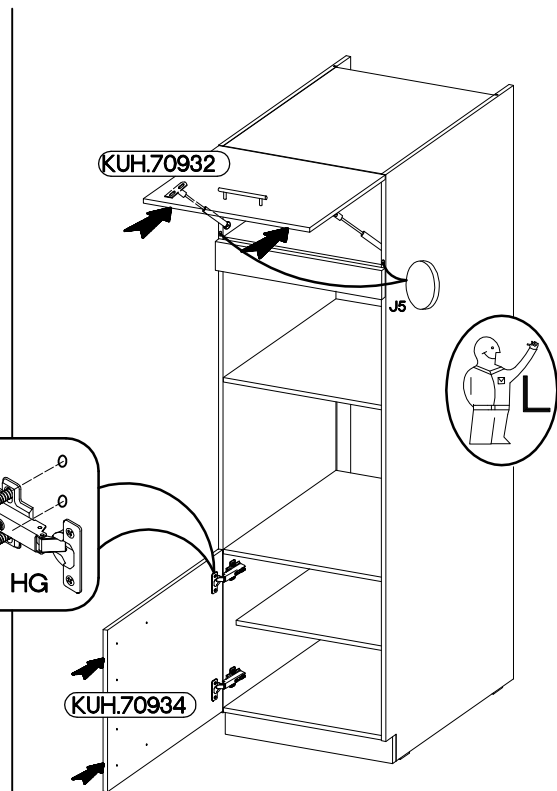
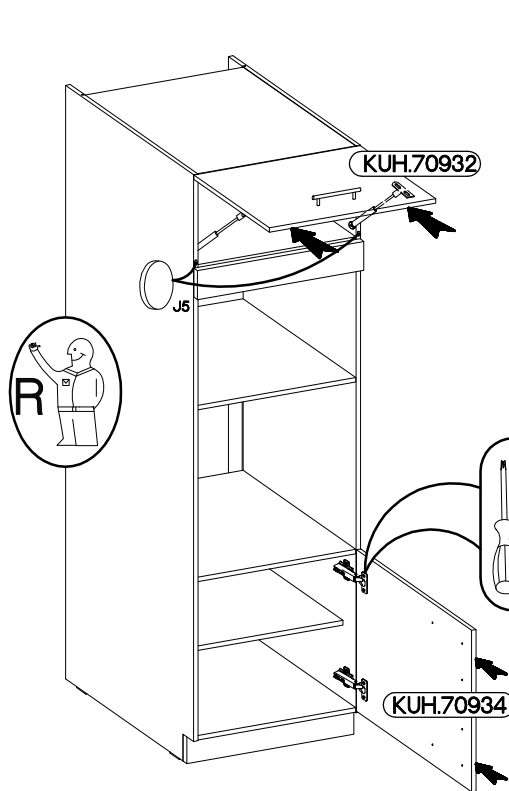
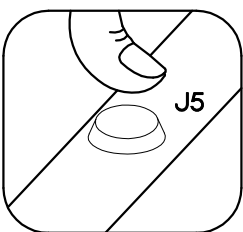
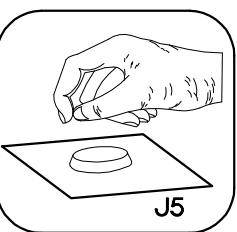
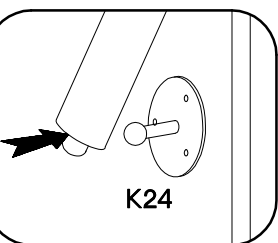
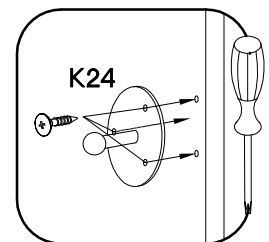
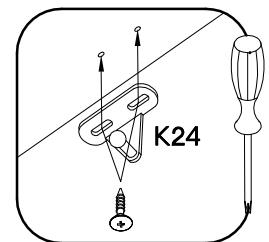
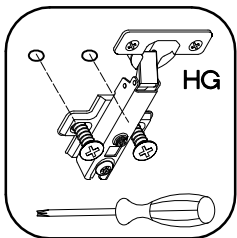
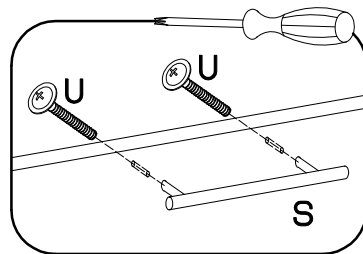

5

M4x22mm U 4	L=128mm S 2	K24 2	J5 2
-------------------	-------------------	----------	---------



VARIANT HIGH GLOSS

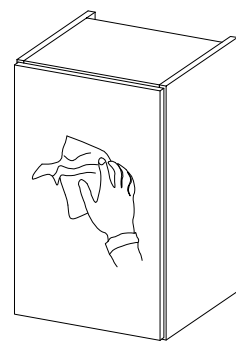
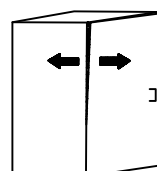
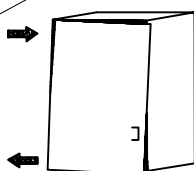
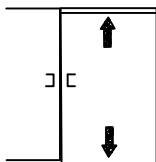
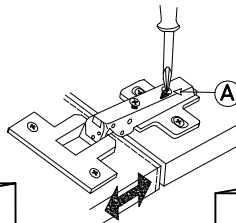
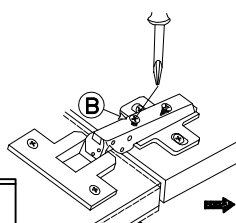
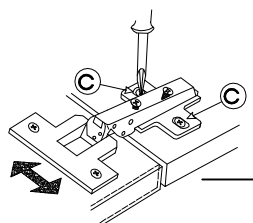
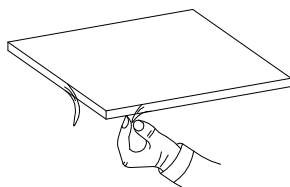

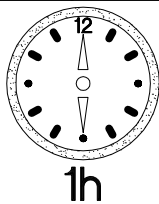
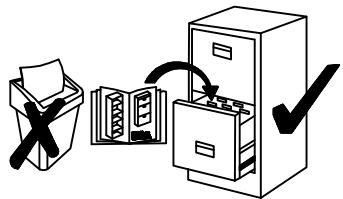
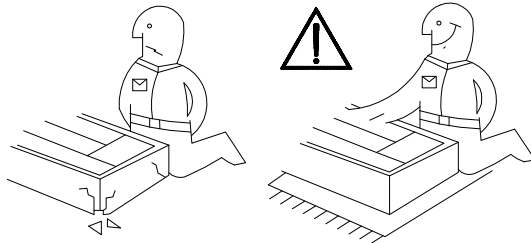
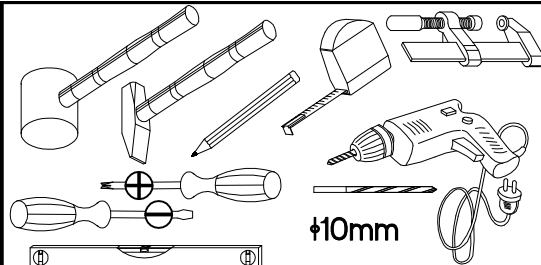
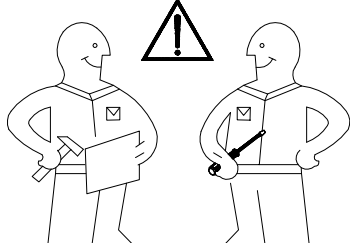

60 DPM-2100 2F

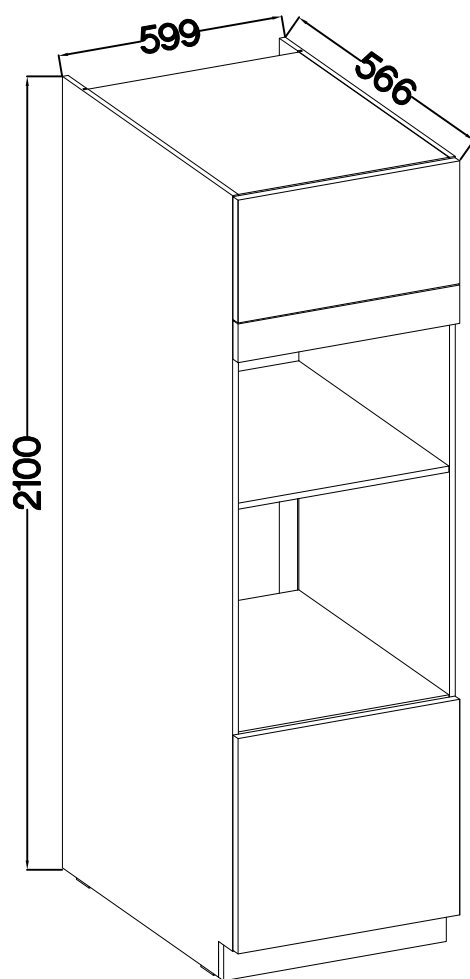
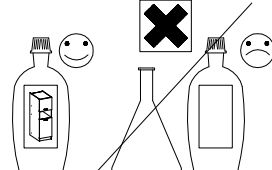

max. 10kg  
 KUH.30002  
 KUH.40007  
 KUH.40008

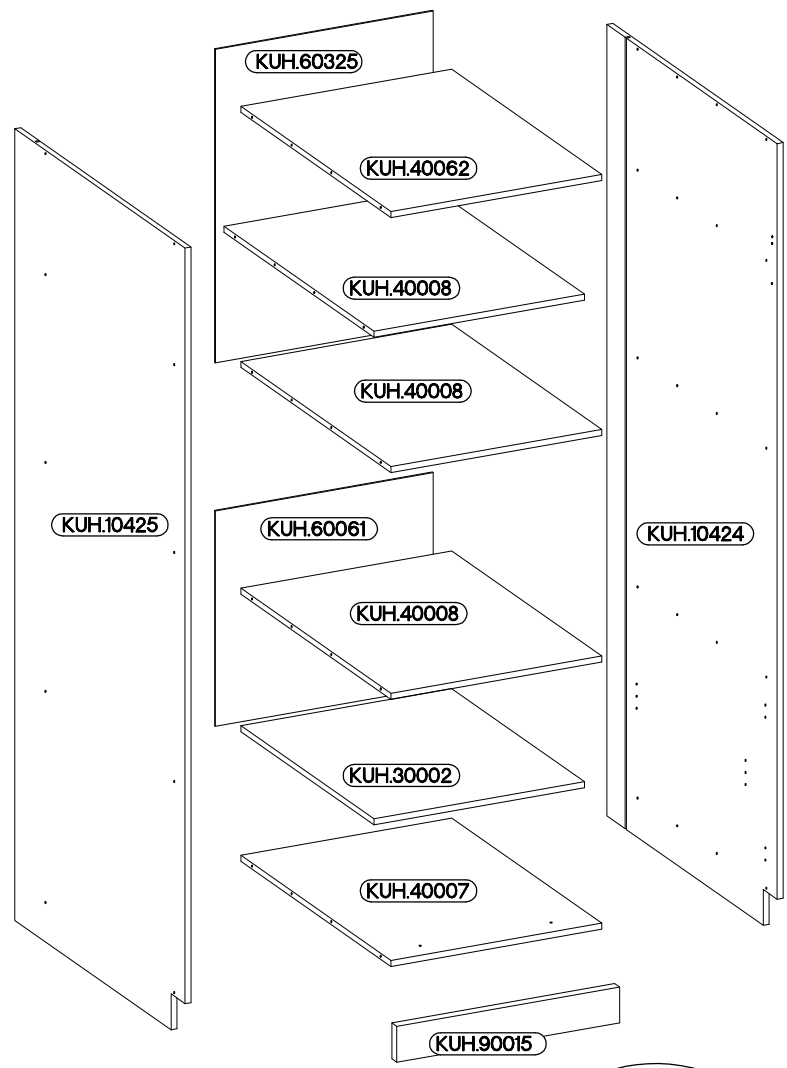

 A 20	 B 20
-------------	-------------

 E1 20	 E9 2	 F2 4	 HG 4	 J 4	 J5 2	 K24 2
 L25 1	 O 1	 P1 4	 P4 2	 P5 10	 P7 15-20	 T3 2



ISM-KUH-01639

# 1

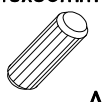
6.5x48x16	+8x30mm
	
F2	A
4	20

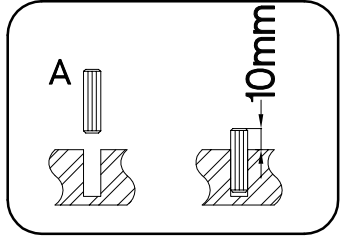
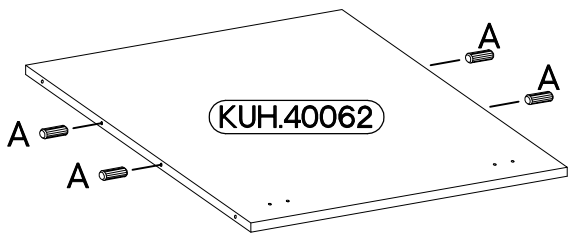
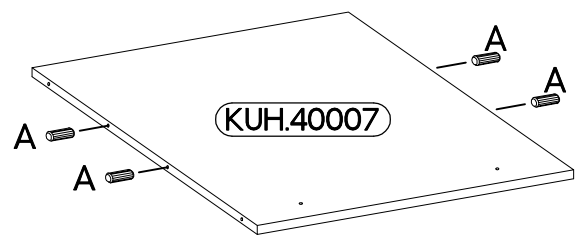
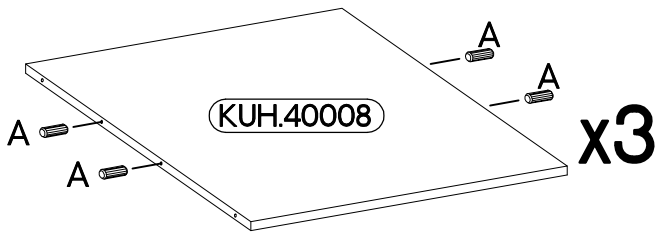
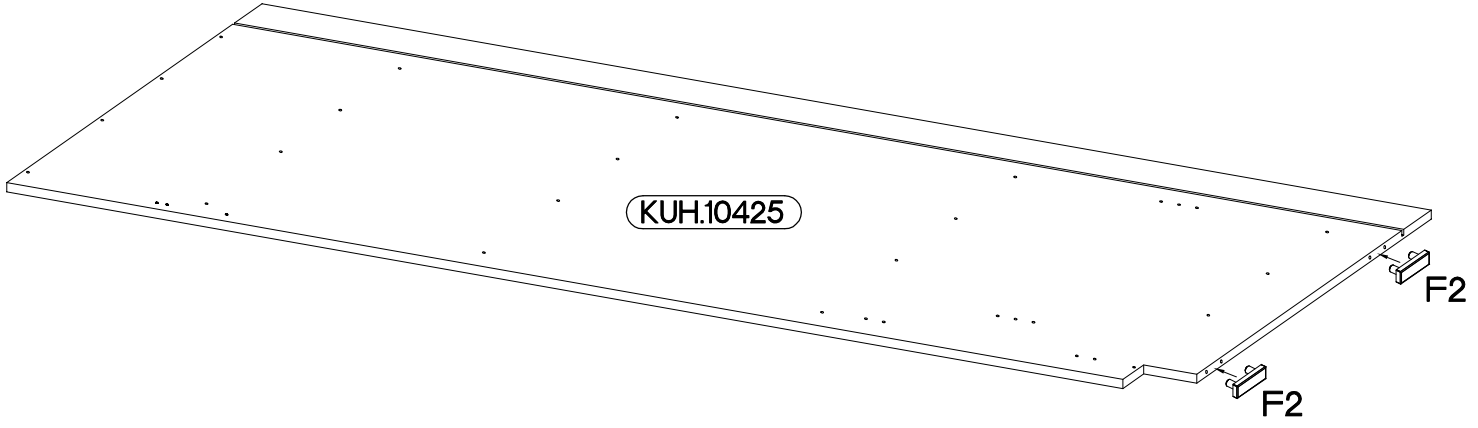
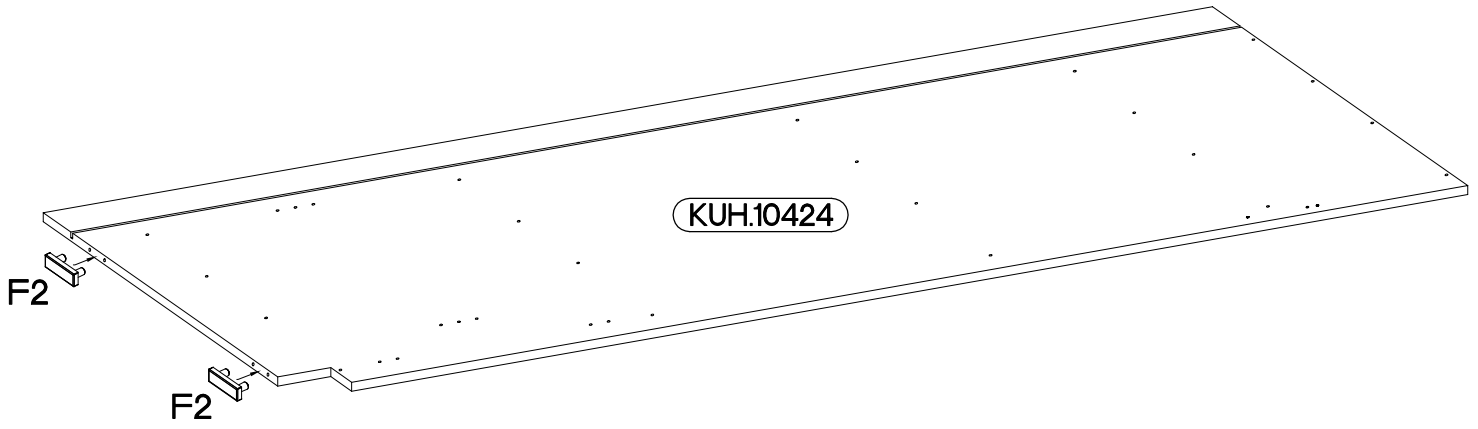
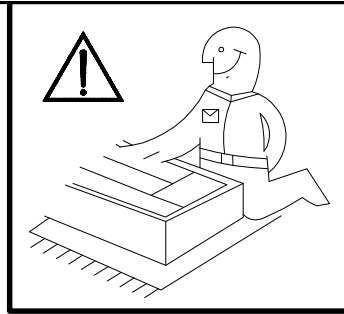
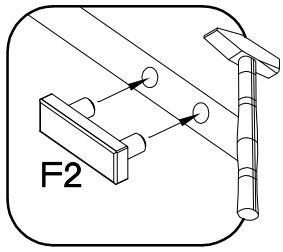

2

6,4 x 50mm

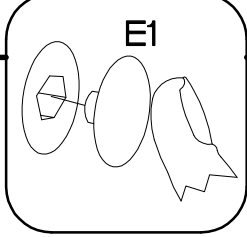
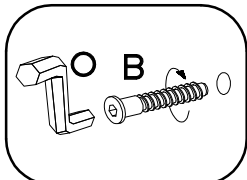
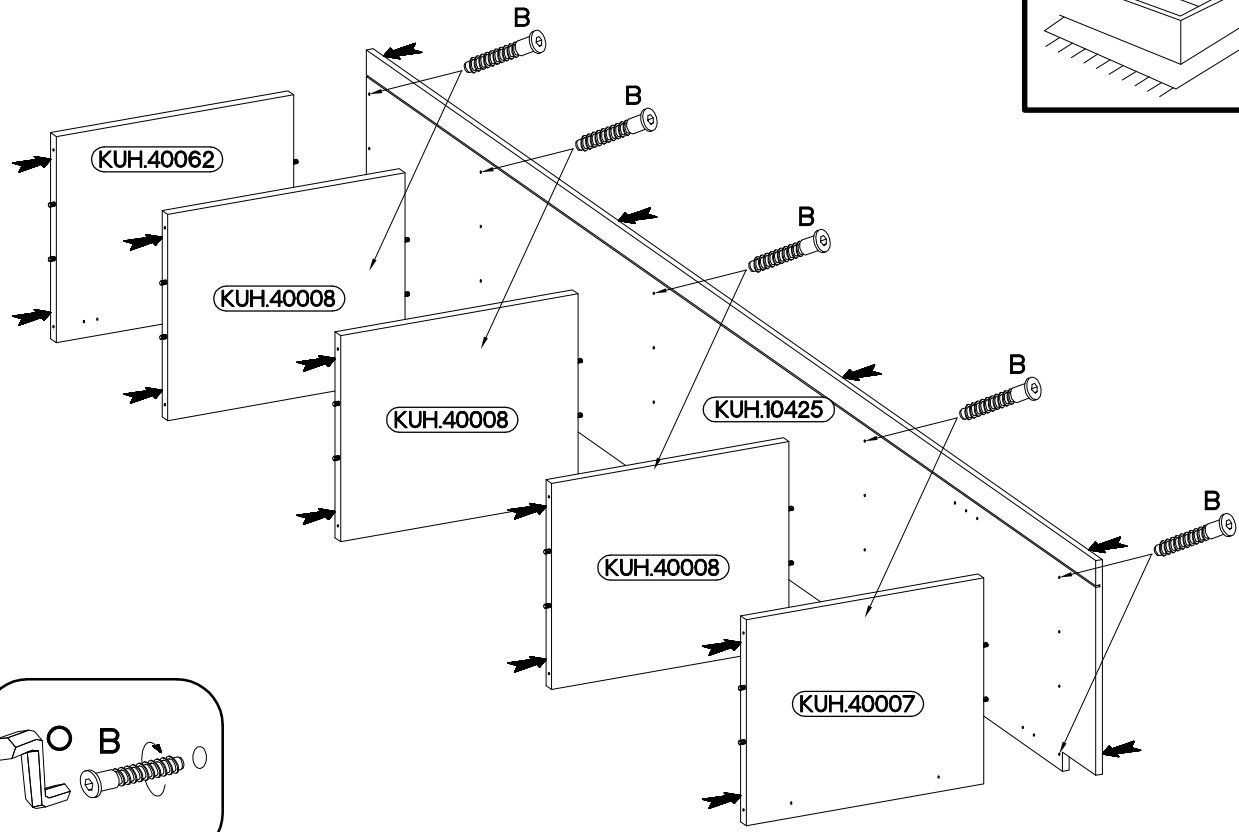
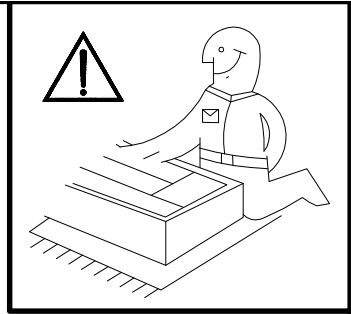
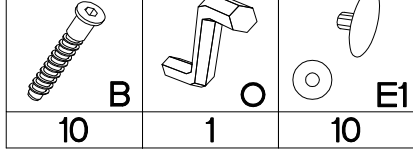

3

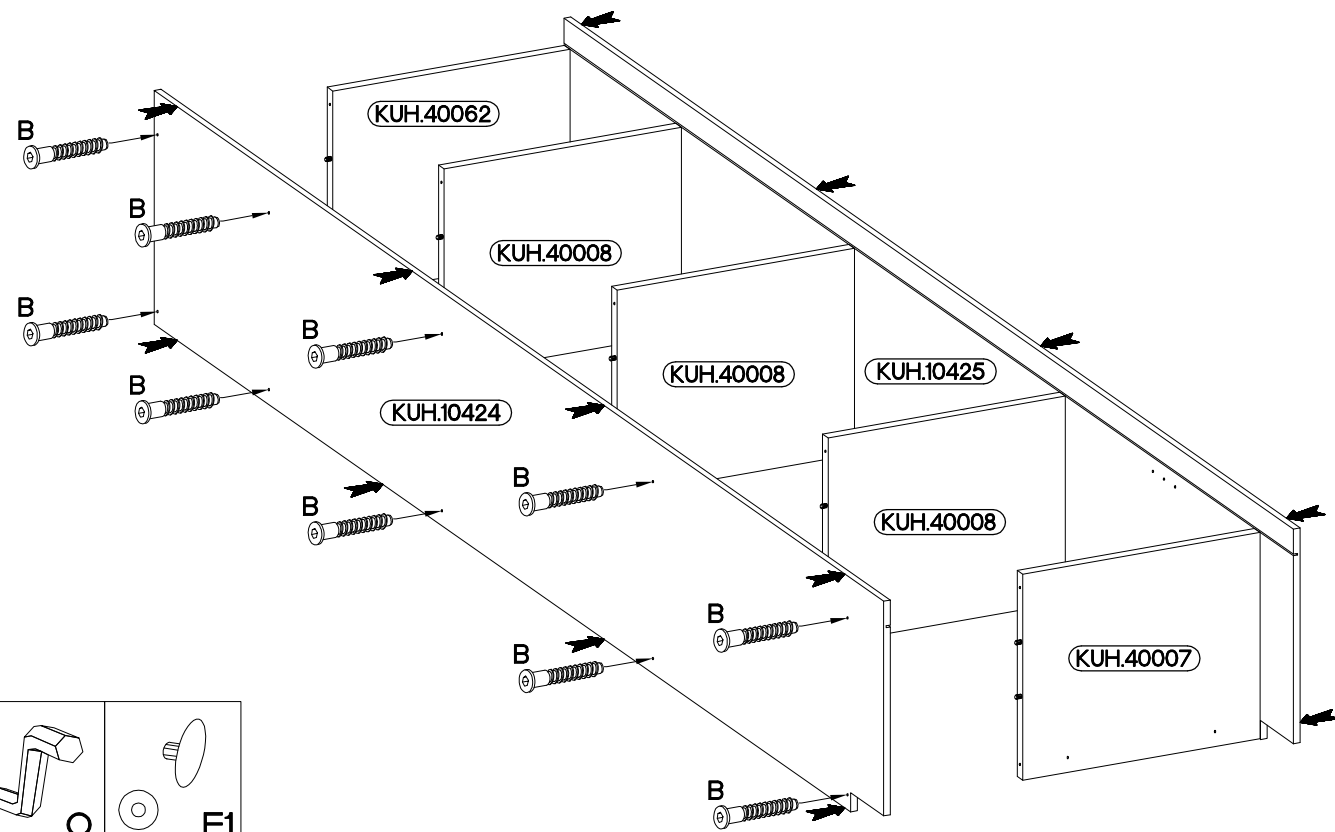

6,4 x 50mm

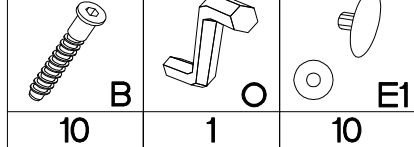



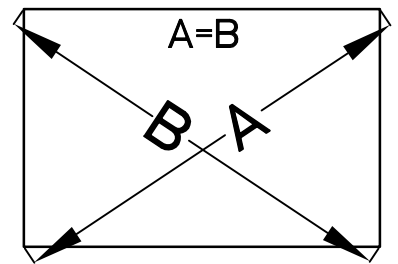
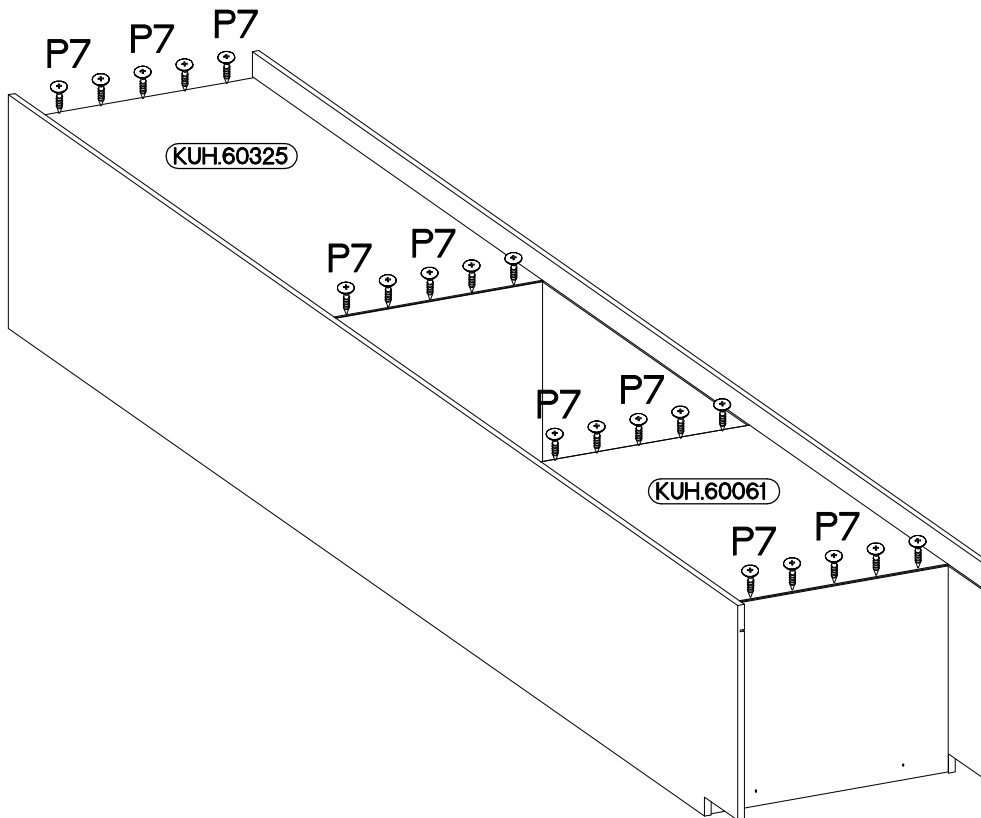
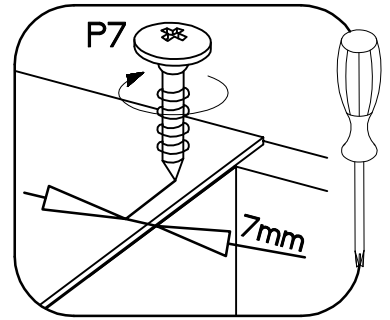
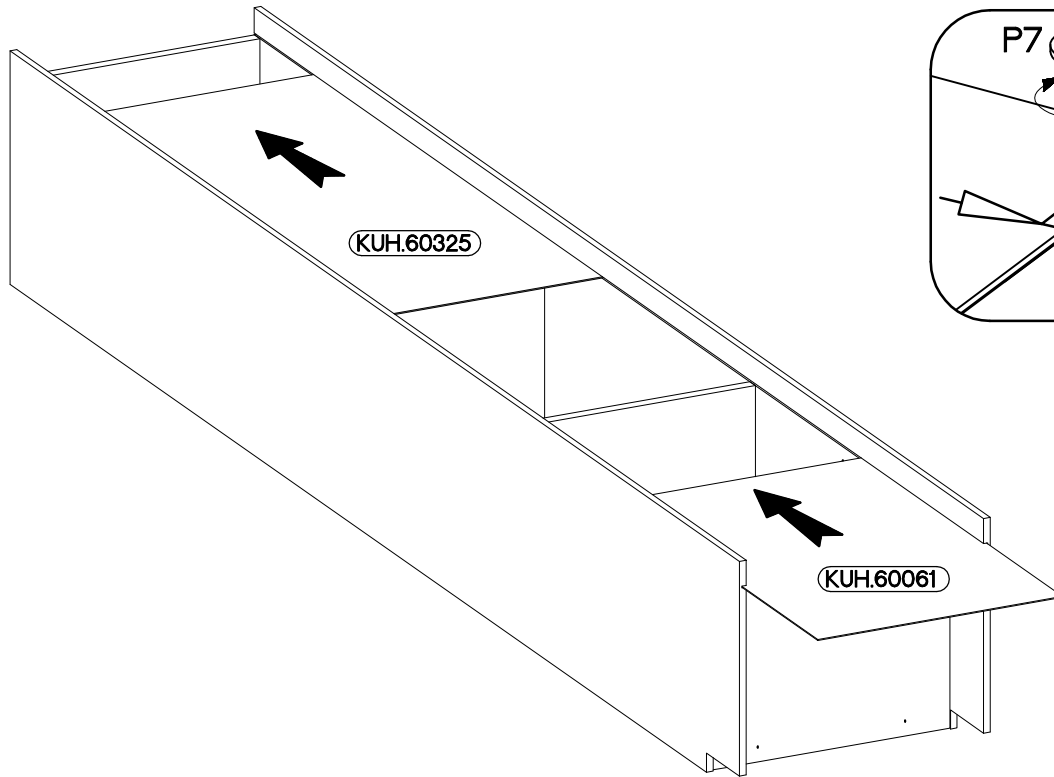
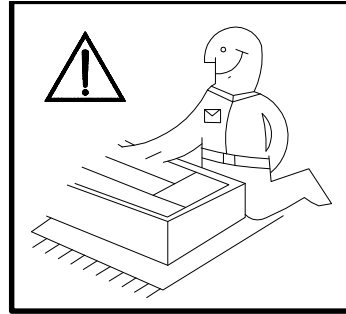

4

±3.0x20mm  
P7  
15-20



# 5

4.0x45mm 	
P4	E9
2	2

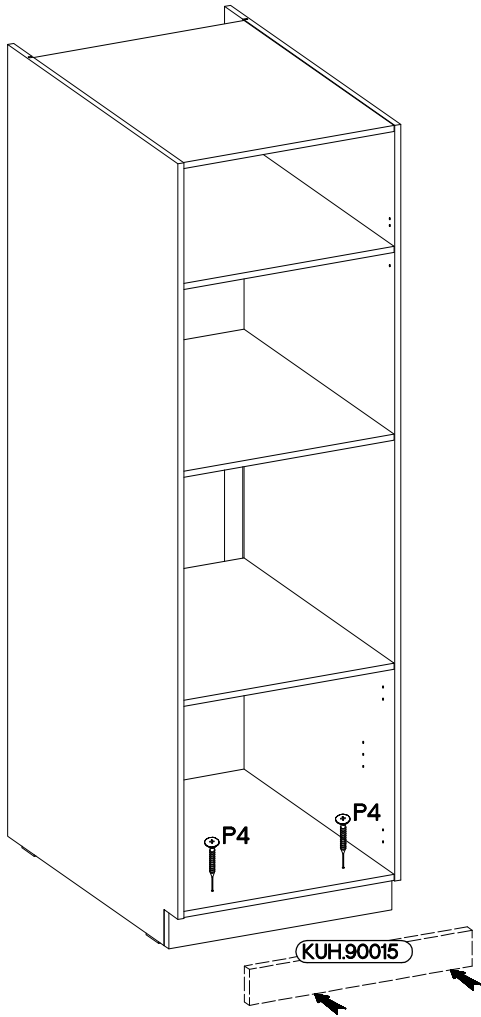

# 6

5/19mm 
J
4

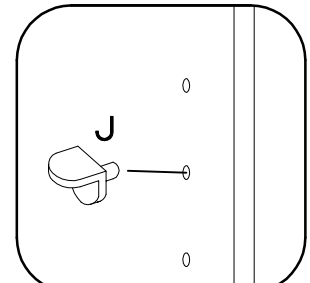
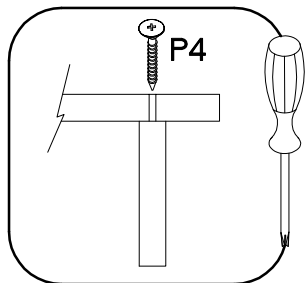
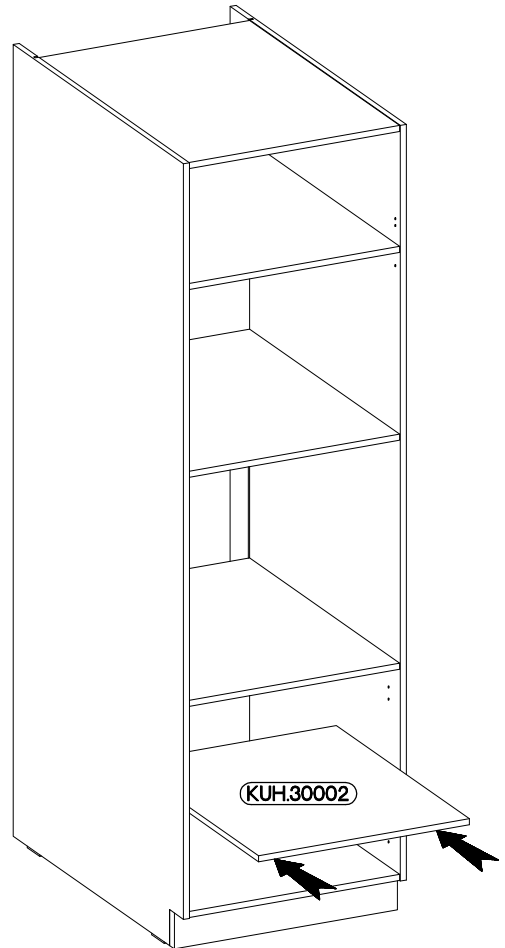

7

120x30x15mm

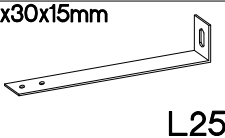

L25

1

φ3.5x13mm



P5

2

1.

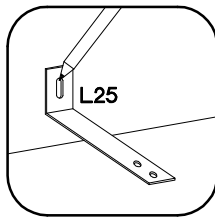

2.

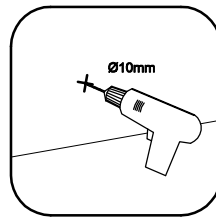

3.

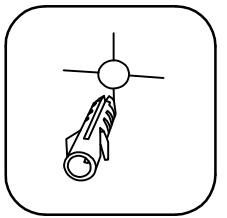

4.

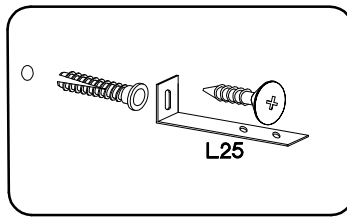

5.

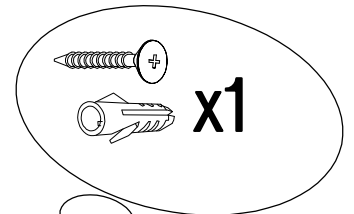
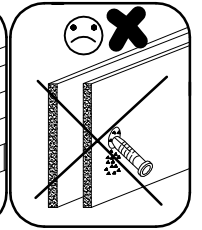
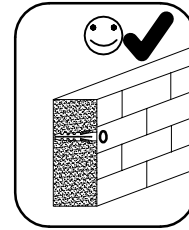
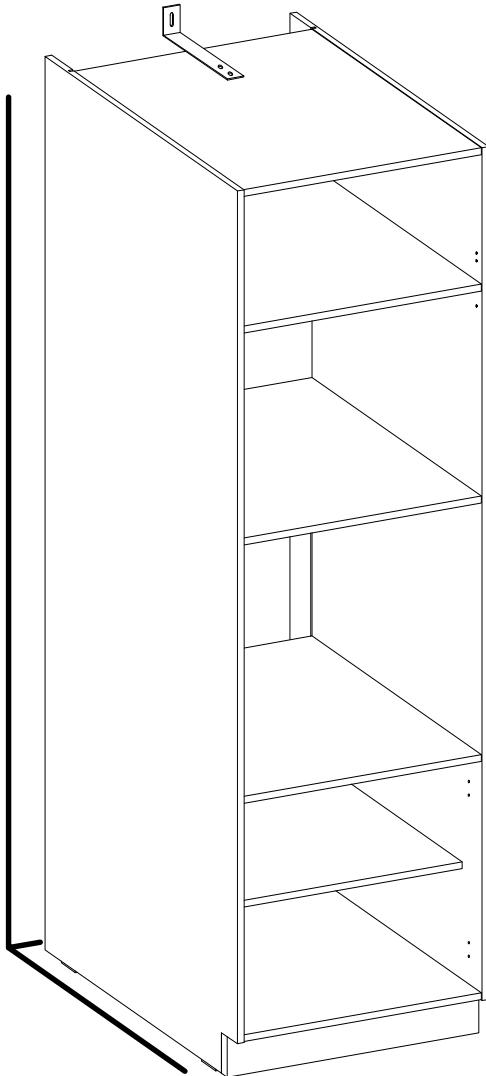
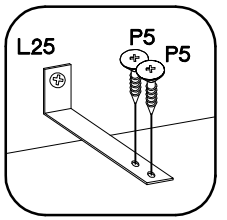

8

FRONT

